

**BEST BUY GLASS LTD**

Unit D 12810 97B St  
Grande Prairie, AB T8V6W3

Phone # 780-532-7488 Fax # 780-513-6682

GST/HST No. 851853770

*J22-19  
MAY*

**Invoice**

Date	Invoice #
2025-07-07	28908

Invoice To
Cariboo Railroad Contracting Corp.

P.O. No.

Terms

Account Number

Customer Bus. No.

Qty	Description	Rate	Amount
1	W/S GMC UNIT 74  Job Code: BC.peace.daw.bid Equipment Unit #: UN74 Comment: <i>Tim Hawryluk</i>	440.00	440.00

**Sales Tax Summary**

GST@5.0% 22.00  
Total Tax 22.00

E-mail	bestbuyglass@live.com
--------	-----------------------

<b>Total</b>	<b>\$462.00</b>
--------------	-----------------

--

RC PARTNERSHIP LTD  
 5480 136TH AVENUE  
 EDMONTON, AB T5A 0E4  
 (780) 478-9750  
 www.mrlube.com



Date	03-Jul-2025 1:16 PM
Invoice #	12662514
Transaction #	25070312662514
License Plate	BC-WJ8879

<b>Customer Information</b> CONTRACT CARIBOO RAILROAD 209-307 BANKS RD Kelowna, BC V1X 6A1 (778) 478-1745		<b>Vehicle Information</b> KILOMETERS 199215 2021 GMC Sierra 3500 HD SLE 8Cyl 6.6L 403 MFI OHV DIESEL Turbo L5P 445hp Duramax (Y) VIN 1GT49TEYXMF139322																																														
<b>Fleets</b> RCARCEN N CARIBOO RAILROAD CONTRACTING		<b>Service History</b> <table border="1"> <thead> <tr> <th>DATE</th> <th>KILOMETERS</th> <th>SERVICES</th> </tr> </thead> <tbody> <tr> <td>03-Jul-2025</td> <td>199215</td> <td>OC4 WW</td> </tr> <tr> <td>08-Mar-2025</td> <td>188541</td> <td>OC4 WW AF</td> </tr> </tbody> </table>		DATE	KILOMETERS	SERVICES	03-Jul-2025	199215	OC4 WW	08-Mar-2025	188541	OC4 WW AF																																				
DATE	KILOMETERS	SERVICES																																														
03-Jul-2025	199215	OC4 WW																																														
08-Mar-2025	188541	OC4 WW AF																																														
X I have agreed to the information contained on this invoice.		<table border="1"> <thead> <tr> <th>Description</th> <th>QTY</th> <th>Price</th> </tr> </thead> <tbody> <tr> <td>PREMIUM SYN DIESEL PKG</td> <td>1.00</td> <td>219.99</td> </tr> <tr> <td>SHOP SUPPLIES</td> <td>1.00</td> <td>7.99</td> </tr> <tr> <td>COURTESY CHECK</td> <td>1.00</td> <td>0.00</td> </tr> <tr> <td>OIL FILTER PH10063</td> <td>1.00</td> <td>0.00</td> </tr> <tr> <td>MOBIL DELVAC 1 5W40 ESP</td> <td>9.50</td> <td>0.00</td> </tr> <tr> <td>TIRE PRESSURE IS ===&gt;</td> <td>60.80</td> <td>0.00</td> </tr> <tr> <td>FACTORY SEALED VEHICLE</td> <td>1.00</td> <td>0.00</td> </tr> <tr> <td>FREE WASHER FLUID TOP-UP</td> <td>1.00</td> <td>0.00</td> </tr> <tr> <td>WINTER WASHER FLUID BULK</td> <td>1.00</td> <td>0.00</td> </tr> <tr> <td>BATTERY TEST PASSED</td> <td>1.00</td> <td>0.00</td> </tr> <tr> <td><b>SALE</b></td> <td></td> <td><b>\$227.98</b></td> </tr> <tr> <td>831770441-RT0001</td> <td></td> <td>11.40</td> </tr> <tr> <td><b>TOTAL</b></td> <td></td> <td><b>\$239.38</b></td> </tr> <tr> <td>CHARGE</td> <td></td> <td>239.38</td> </tr> </tbody> </table>		Description	QTY	Price	PREMIUM SYN DIESEL PKG	1.00	219.99	SHOP SUPPLIES	1.00	7.99	COURTESY CHECK	1.00	0.00	OIL FILTER PH10063	1.00	0.00	MOBIL DELVAC 1 5W40 ESP	9.50	0.00	TIRE PRESSURE IS ===>	60.80	0.00	FACTORY SEALED VEHICLE	1.00	0.00	FREE WASHER FLUID TOP-UP	1.00	0.00	WINTER WASHER FLUID BULK	1.00	0.00	BATTERY TEST PASSED	1.00	0.00	<b>SALE</b>		<b>\$227.98</b>	831770441-RT0001		11.40	<b>TOTAL</b>		<b>\$239.38</b>	CHARGE		239.38
Description	QTY	Price																																														
PREMIUM SYN DIESEL PKG	1.00	219.99																																														
SHOP SUPPLIES	1.00	7.99																																														
COURTESY CHECK	1.00	0.00																																														
OIL FILTER PH10063	1.00	0.00																																														
MOBIL DELVAC 1 5W40 ESP	9.50	0.00																																														
TIRE PRESSURE IS ===>	60.80	0.00																																														
FACTORY SEALED VEHICLE	1.00	0.00																																														
FREE WASHER FLUID TOP-UP	1.00	0.00																																														
WINTER WASHER FLUID BULK	1.00	0.00																																														
BATTERY TEST PASSED	1.00	0.00																																														
<b>SALE</b>		<b>\$227.98</b>																																														
831770441-RT0001		11.40																																														
<b>TOTAL</b>		<b>\$239.38</b>																																														
CHARGE		239.38																																														
<b>Messages</b> SEE US FOR YOU NEXT SET OF TIRES! MR. LUBE NOW OFFERS THE FULL RANGE OF TIRE SERVICE, INCLUDING NEW TIRES!		<b>Recommend next service on 01-Oct-2025 or 204215 km.</b>																																														
<b>Employees</b> <table border="1"> <thead> <tr> <th>UPPER</th> <th>LOWER</th> <th>COURTESY</th> <th>MOD</th> <th>TORQUE</th> <th>INSTALL</th> </tr> </thead> <tbody> <tr> <td>HARM</td> <td>MIKEH</td> <td>HARM</td> <td>JASON</td> <td></td> <td></td> </tr> </tbody> </table>		UPPER	LOWER	COURTESY	MOD	TORQUE	INSTALL	HARM	MIKEH	HARM	JASON			<b>Service Comments</b> THANK YOU! HAVE A NICE DAY!																																		
UPPER	LOWER	COURTESY	MOD	TORQUE	INSTALL																																											
HARM	MIKEH	HARM	JASON																																													
<b>Warranty Approved Service</b> At Mr. Lube, oil changes are warranty-approved and Mr. Lube precisely follows the service intervals and product specifications your vehicle's manufacturer recommends for the exact make, model and year of your car.																																																

Job Code: BC.PEACE.DAW.BI  
 Equipment Unit #: UN74

*Tim Hawryluk*

# Complete our survey and receive a chance to WIN!

- ✓ Win a FREE oil change weekly
- ✓ Receive 10 chances to win \$1,000 daily\*
- ✓ You could instantly win other great prizes valued at \$1,500 weekly\*

## We value your feedback.

Rate us at [www.tellmrlube.com](http://www.tellmrlube.com), or call 1-866-681-4932 and you could win a free oil change weekly!

PLUS receive a chance to win daily cash and other great prizes by visiting [tellmrlube.com](http://tellmrlube.com) or calling 1-866-681-4932

Survey Code:  
 186A038KAF

Enter this code at [tellmrlube.com](http://tellmrlube.com)

\*Check inmoment.com for contest details. © Reg. TM/MD of ML Royalties Limited Partnership, used under license.

RC PARTNERSHIP LTD  
 5480 136TH AVENUE  
 EDMONTON, AB T5A 0E4  
 (780) 478-9750  
 www.mrlube.com



Date	03-Jul-2025 1:16 PM
Invoice #	12662514
Transaction #	25070312662514
License Plate	BC-WJ8879

**Courtesy Checklist**

**COURTESY CHECK / DOUBLE CHECK**

CHECKS:		-Lights	CHECKED OK
-Washer Fluid	TOPUP	-Leaks (Fluid, Oil)	APPEARS OK
-Coolant Fluid	LEVEL OK	<b>TIRE SERVICE CHECKS:</b>	
-Power Steering Fluid	LEVEL OK	-Tire Pressure	TIRE PRESSURE OK
-Serpentine Belt	APPEARS OK	<b>DOUBLE CHECKS:</b>	
-Air Filter	APPEARS OK	-Oil Pan Drain Plug	CHECK
-Cabin Air Filter	NO CHECK	-Oil Filter	CHECK
-Battery	PASS	-Front Differential Plug	CHECK
-Wash Windows	COMPLETED	-Transfer Case/PTU Plug	CHECK
-Wiper Blades Front/Rear	NO CHECK	-Rear Differential Plug	CHECK
-Windshield	NO CHECK	-Oil Light Reset	RESET
-Transmission/Transaxle Fluid	LEVEL OK		

**DISCLAIMER**

RC PARTNERSHIP LTD is the "Operator" of this Mr. Lube Store. BE ADVISED that the courtesy checks provided in connection with the servicing of your vehicle are provided solely as a courtesy and for your information only. The Operator does not represent or warrant that the courtesy checks are in any way comprehensive or that the results of the courtesy checks are accurate. The Operator disclaims any and all responsibility for ensuring that your vehicle is in proper working condition with respect to the parts, components or matters inspected or reviewed in the courtesy checks or that it is safe for you or any other person to operate. In no event will the Operator or any of its directors, officers, employees, agents or representatives be liable in any way for any loss or damage whatsoever (including personal injury or death) resulting or arising from, or in any way connected with, any failure of any of the parts, components or matters inspected or reviewed in the courtesy checks.

# Complete our survey and receive a chance to WIN!

- ✓ Win a FREE oil change weekly
- ✓ Receive 10 chances to win \$1,000 daily\*
- ✓ You could instantly win other great prizes valued at \$1,500 weekly\*

**We value your feedback.**

Rate us at [www.tellmrlube.com](http://www.tellmrlube.com), or call 1-866-681-4932 and you could win a free oil change weekly!

**PLUS** receive a chance to win daily cash and other great prizes by visiting [tellmrlube.com](http://tellmrlube.com) or calling 1-866-681-4932

**Survey Code:**  
 186A038KAF

Enter this code at [tellmrlube.com](http://tellmrlube.com)

\*Check [inmoment.com](http://inmoment.com) for contest details. © Reg. TM/MD of ML Royalties Limited Partnership, used under license.



**WINDSOR FORD**  
 10001 139 Avenue • Grande Prairie, AB • T8X 0V3  
 Tel: (780) 532-9555 • 1-800-422-6094  
 service@windsorford.com • www.windsorford.com  
**SERVICE HOURS - Mon - Fri 7:30 A.M. - 6:00 P.M.**  
**Saturday - 8:00 A.M. - 5:00 P.M.**

**GENUINE PEOPLE  
 TREATING YOU LIKE  
 A PERSON**

**OUR REPUTATION IS  
 YOUR EXPERIENCE**

**SO # 602507**

Status  
 Printed 07/31/2025 11:52:13 AM

**SERVICE ORDER  
 CUSTOMER COPY**



User 1334 Page 1

**Customer No**  
 Cariboo Railroad Contracting Corp.  
 3030 Pandosy Unit # #117  
 Kelowna, BC V1Y 0C4

**Home**                      **Bus** (778) 478-1745  
**Cell**                        **Today**  
**Email**

**Type**  
**Term Charge**

<b>Advisor</b> Nicole L	<b>Location</b>	<b>Promised</b> 05/01/2025 6:00 PM
<b>Shop</b> QL	<b>PO #</b>	<b>Opened</b> 05/01/2025 4:03 PM
<b>Tag#</b> 7715	<b>UNIT 74</b>	<b>Cashiered</b> 05/01/2025 6:01 PM

<b>License</b> WV 7353	<b>Odom In</b> 241078	<b>Odom Out</b> 241078	<b>In Service Date</b>	<b>Stock No</b>
<b>Year</b> 2018	<b>Make</b> CHEVROLET	<b>Model</b> SILVERADO 3500HD	<b>Model Number</b> CK36043	<b>Colour</b> WHITE
<b>Vehicle ID No</b> 1GB4KYCG2JF246800	<b>Selling Dealer</b>	<b>Extended Warranty</b>	<b>Delivery Date</b>	
<b>Engine</b> VORTEC 6.0L VARIABLE VALVE			72	

Request	Description	Job	CSR	Status
QL102	"The Works Pkgs" Change oil and filter. Check all lights, belts, hoses and related components. as per Ford we remove tires and rotate every time.	1	NICOLE	Original

removal of tires YES or DECLINED

Replace air filter only if dirty...                      yes or Declined  
 Replace cabin air filter only if dirty..              Yes or Declined

Engine Hours if Diesel: \_\_\_\_\_

Please retorque your wheels after 150km. Please come to the back of the building and press the green button under the retorque sign. This will allow you to have minimal wait time.  
 If you have after market wheels, you may see the centre caps in your cab. We will re install them when you come for your retorque. - Thank you for understanding .

Did we use the customers locking key.. Yes or No

Tech # \_\_\_\_\_ & \_\_\_\_\_

Labour	Description	Type	Amount
QL102	"The Works Pkgs" Change oil and filter. Check all lights, belts, hoses and related components. as per Ford we remove tires and rotate every time.	CQL	62.50

removal of tires YES or DECLINED

Replace air filter only if dirty...                      yes or Declined  
 Replace cabin air filter only if dirty..              Yes or Declined

Engine Hours if Diesel: \_\_\_\_\_

Please retorque your wheels after 150km. Please come to the back of the building and press the green button under the retorque sign. This will allow you to have minimal wait time.  
 If you have after market wheels, you may see the centre caps in your cab. We will re install them when you come for your retorque. - Thank you for understanding .

Did we use the customers locking key.. Yes or No

**TERMS: STRICTLY CASH UNLESS ARRANGEMENTS ARE MADE.** "I hereby authorize the repair work hereinafter to be done along with the necessary material and agree that you are not responsible for loss or damage to vehicle or articles left in the vehicle in case of fire, theft, or any other cause beyond your control or for any delays caused by unavailability of parts or delays in parts shipments by the supplier or transporter. I hereby grant you or your employees permission to operate the vehicle herein described on streets, highways, or elsewhere for the purpose of testing and/or inspection. An express mechanic's lien is hereby acknowledged on above vehicle to secure the amount of repairs thereto."

**DISCLAIMER OF WARRANTIES:** Any warranties on the products sold hereby are those made by the manufacturer. The seller hereby expressly disclaims all warranties either express or implied, including any implied warranty of merchantability or fitness for a particular purpose, and the seller neither assumes or authorizes any other person to assume for it any liability in connection with the sale of said products. Any limitation contained herein does not apply where prohibited by law.

**PRIVACY STATEMENT:** Personal information is collected in accordance with applicable privacy legislation and is governed by the Dealer's Privacy Policy. Your privacy is important to us. Ask us if you would like information about our Privacy Policy. We provide this personal information to Ford Motor Company of Canada Limited (together with third parties acting on its behalf "Ford") to enable Ford to administer your transaction, to provide you with services, to improve automotive related products and services by conducting customer surveys, and to provide you with marketing material which may be of interest to you. To obtain the Ford Privacy Policy or if you do not want to receive marketing or survey materials from Ford please call 1-800-565-FORD (3673).

**NO RETURN ON ELECTRICAL OR SAFETY ITEMS OR SPECIAL ORDERS**

**DISCLAIMER:** Wheel lug nuts must be retorqued 100km after any wheel has been removed. This is the CUSTOMERS responsibility.

Customer Signature: \_\_\_\_\_

GST# 10570 8457 RT0001

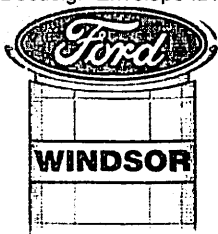

**WINDSOR FORD**  
 10001 139 Avenue • Grande Prairie, AB • T8X 0V3  
 Tel: (780) 532-9555 • 1-800-422-6094  
 service@windsorford.com • www.windsorford.com  
 SERVICE HOURS - Mon - Fri 7:30 A.M. - 6:00 P.M.  
 Saturday - 8:00 A.M. - 5:00 P.M.

**GENUINE PEOPLE  
 TREATING YOU LIKE  
 A PERSON**

**OUR REPUTATION IS  
 YOUR EXPERIENCE**

**SO # 602507**

**SERVICE ORDER  
 CUSTOMER COPY**



Status  
 Printed 07/31/2025 11:52:13 AM

User 1334 Page 2

**Customer No**  
 Cariboo Railroad Contracting Corp.  
 3030 Pandosy Unit # #117  
 Kelowna, BC V1Y 0C4

**Home Cell Email**

**Bus Today** (778) 478-1745

**Type Term Charge**

<b>Advisor</b> Nicole L	<b>Location</b>	<b>Promised</b> 05/01/2025 6:00 PM
<b>Shop</b> QL	<b>PO #</b>	<b>Opened</b> 05/01/2025 4:03 PM
<b>Tag#</b> 7715	<b>UNIT 74</b>	<b>Cashiered</b> 05/01/2025 6:01 PM

<b>License</b> WV 7353	<b>Odom In</b> 241078	<b>Odom Out</b> 241078	<b>In Service Date</b>	<b>Stock No</b>
<b>Year Make</b> 2018 CHEVROLET	<b>Model</b> SILVERADO 3500HD	<b>Model Number</b> CK36043	<b>Colour</b> WHITE	<b>Delivery Date</b>
<b>Vehicle ID No</b> 1GB4KYCG2JF246800	<b>Selling Dealer</b>	<b>Extended Warranty</b>		
<b>Engine</b> VORTEC 6.0L VARIABLE VALVE		72		

Tech # \_\_\_\_\_ & \_\_\_\_\_

Part	Description	Shp	Bin	Type	Retail	Price	Amount
QFL 25	KIT - ELEMENT & GASK	1	QL	CQL16	19.48	19.48	19.48
ENFILT	TXLEV ENVIRO FEE	1	SPORD	CQL16	0.60	0.60	0.60
ENOIL	TXLEV ENVIRO FEE OIL	5.8	SPORD	CQL16	0.10	0.10	0.58
CXO 5W30 BSP	MOTORCRAFT SAE 5W-30	5.8	SHOP	CQL16	6.98	6.98	40.48
Technician 1372 -				<b>Parts Total</b>			61.14
<b>Cause</b>	"The Works Pkgs" Change oil and filter. Check all lights, belts, hoses and related components.			<b>Labour Total</b>			62.50
	as per Ford we remove tires and rotate every time.			<b>Request Sub-total</b>			123.64

removal of tires YES or DECLINED

Replace air filter only if dirty... yes or Declined  
 Replace cabin air filter only if dirty.. Yes or Declined

Engine Hours if Diesel: \_\_\_\_\_

Please retorque your wheels after 150km. Please come to the back of the building and press the green button under the retorque sign. This will allow you to have minimal wait time.

If you have after market wheels, you may see the centre caps in your cab. We will re install them when you come for your retorque. - Thank you for understanding .

Did we use the customers locking key.. Yes or No

Tech # \_\_\_\_\_ & \_\_\_\_\_

**TERMS: STRICTLY CASH UNLESS ARRANGEMENTS ARE MADE.** "I hereby authorize the repair work hereinafter to be done along with the necessary material and agree that you are not responsible for loss or damage to vehicle or articles left in the vehicle in case of fire, theft, or any other cause beyond your control or for any delays caused by unavailability of parts or delays in parts shipments by the supplier or transporter. I hereby grant you or your employees permission to operate the vehicle herein described on streets, highways, or elsewhere for the purpose of testing and/or inspection. An express mechanic's lien is hereby acknowledged on above vehicle to secure the amount of repairs thereto."

**DISCLAIMER OF WARRANTIES:** Any warranties on the products sold hereby are those made by the manufacturer. The seller hereby expressly disclaims all warranties either express or implied, including any implied warranty of merchantability or fitness for a particular purpose, and the seller neither assumes or authorizes any other person to assume for it any liability in connection with the sale of said products. Any limitation contained herein does not apply where prohibited by law.

**PRIVACY STATEMENT:** Personal information is collected in accordance with applicable privacy legislation and is governed by the Dealer's Privacy Policy. Your privacy is important to us. Ask us if you would like information about our Privacy Policy. We provide this personal information to Ford Motor Company of Canada Limited (together with third parties acting on its behalf "Ford") to enable Ford to administer your transaction, to provide you with services, to improve automotive related products and services by conducting customer surveys, and to provide you with marketing material which may be of interest to you. To obtain the Ford Privacy Policy or if you do not want to receive marketing or survey materials from Ford please call 1-800-565-FORD (3673).

**NO RETURN ON ELECTRICAL OR SAFETY ITEMS OR SPECIAL ORDERS**

**DISCLAIMER:** Wheel lug nuts must be retorqued 100km after any wheel has been removed. This is the CUSTOMERS responsibility.

Customer Signature: \_\_\_\_\_

GST# 10570 8457 RT0001

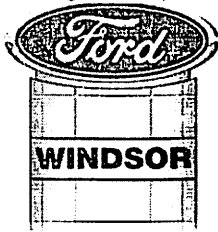

**WINDSOR FORD**  
 10001 139 Avenue • Grande Prairie, AB • T8X 0V3  
 Tel: (780) 532-9555 • 1-800-422-6094  
 service@windsorford.com • www.windsorford.com  
**SERVICE HOURS - Mon - Fri 7:30 A.M. - 6:00 P.M.**  
**Saturday - 8:00 A.M. - 5:00 P.M.**

**GENUINE PEOPLE  
 TREATING YOU LIKE  
 A PERSON**

**OUR REPUTATION IS  
 YOUR EXPERIENCE**

**SO # 602507**

Status  
 Printed 07/31/2025 11:52:13 AM

**SERVICE ORDER  
 CUSTOMER COPY**



User 1334 Page 3

**Customer No**  
 Cariboo Railroad Contracting Corp.  
 3030 Pandosy Unit # #117  
 Kelowna, BC V1Y 0C4

**Home**                      **Bus** (778) 478-1745  
**Cell**                        **Today**  
**Email**

**Type**  
**Term Charge**

<b>Advisor</b> Nicole L	<b>Location</b>	<b>Promised</b> 05/01/2025 6:00 PM
<b>Shop</b> QL	<b>PO #</b>	<b>Opened</b> 05/01/2025 4:03 PM
<b>Tag#</b> 7715	<b>UNIT 74</b>	<b>Cashiered</b> 05/01/2025 6:01 PM

<b>License</b> WV 7353	<b>Odom In</b> 241078	<b>Odom Out</b> 241078	<b>In Service Date</b>	<b>Stock No</b>
<b>Year</b> 2018	<b>Make</b> CHEVROLET	<b>Model</b> SILVERADO 3500HD	<b>Model Number</b> CK36043	<b>Colour</b> WHITE
<b>Vehicle ID No</b> 1GB4KYCG2JF246800	<b>Selling Dealer</b>	<b>Extended Warranty</b>	<b>Delivery Date</b>	
<b>Engine</b> VORTEC 6.0L VARIABLE VALVE		72		

Correction Completed: "The Works Pkgs".  
 Changed oil and replaced oil filter, reset oil life and placed service sticker in WS.  
 Checked lights, belts, hoses and related components. (Good)  
 Checked steering and suspension components. (Good)  
 Checked batteries (Passed load test)  
 Checked brake fluid, power steering fluid, and coolant reservoirs. (Good)  
 Checked and filled washer fluid. (Good)  
 Checked tire tread and tire pressures. (Good)  
 Vehicle started, checked final oil level and found within specs.

Top: 1372  
 Bottom: 1373

Comment: Engine oil leak needs diagnosis. Air filter housing damaged.

DONE

Request	Description	Job	CSR	Status
QLAIR	REPLACE AIR FILTER	2	NICOLE	Original
Labour	Description	Type	Amount	
QLAIR	REPLACE AIR FILTER	CQL	0.00	
Technician	1372 -			
Cause	REPLACE AIR FILTER			
Correction	Did not replace air filter as the old one was clean. Air filter housing has damage which could be affecting the seal, recommend addressing issue ASAP.			

Request	Description	Job	CSR	Status
Cap	Final Inspection	3	NICOLE	Original
Labour	Description	Type	Amount	
Q99P	WINDSOR FORD SAFETY & RELIABILITY INSPECTION \$49.95 VALUE -NO CHARGE	CQL	0.00	
Technician	1372 -			

Request	Description	Job	CSR	Status
888	CUSTOMER INFORMATION/CONTACT# _____	4	NICOLE	Original

**TERMS: STRICTLY CASH UNLESS ARRANGEMENTS ARE MADE.** "I hereby authorize the repair work hereinafter to be done along with the necessary material and agree that you are not responsible for loss or damage to vehicle or articles left in the vehicle in case of fire, theft, or any other cause beyond your control or for any delays caused by unavailability of parts or delays in parts shipments by the supplier or transporter. I hereby grant you or your employees permission to operate the vehicle herein described on streets, highways, or elsewhere for the purpose of testing and/or inspection. An express mechanic's lien is hereby acknowledged on above vehicle to secure the amount of repairs thereto."

**DISCLAIMER OF WARRANTIES:** Any warranties on the products sold hereby are those made by the manufacturer. The seller hereby expressly disclaims all warranties either express or implied, including any implied warranty of merchantability or fitness for a particular purpose, and the seller neither assumes or authorizes any other person to assume for it any liability in connection with the sale of said products. Any limitation contained herein does not apply where prohibited by law.

**PRIVACY STATEMENT:** Personal information is collected in accordance with applicable privacy legislation and is governed by the Dealer's Privacy Policy. Your privacy is important to us. Ask us if you would like information about our Privacy Policy. We provide this personal information to Ford Motor Company of Canada Limited (together with third parties acting on its behalf "Ford") to enable Ford to administer your transaction, to provide you with services, to improve automotive related products and services by conducting customer surveys, and to provide you with marketing material which may be of interest to you. To obtain the Ford Privacy Policy or if you do not want to receive marketing or survey materials from Ford please call 1-800-565-FORD (3673).

**NO RETURN ON ELECTRICAL OR SAFETY ITEMS OR SPECIAL ORDERS**

**DISCLAIMER:** Wheel lug nuts must be retorqued 100km after any wheel has been removed. This is the CUSTOMERS responsibility.

Customer Signature: \_\_\_\_\_

GST# 10570 8457 RT0001



**WINDSOR FORD**  
 10001 139 Avenue • Grande Prairie, AB • T8X 0V3  
 Tel: (780) 532-9555 • 1-800-422-6094  
 service@windsorford.com • www.windsorford.com  
**SERVICE HOURS - Mon - Fri 7:30 A.M. - 6:00 P.M.**  
**Saturday - 8:00 A.M. - 5:00 P.M.**

**GENUINE PEOPLE  
 TREATING YOU LIKE  
 A PERSON**

**OUR REPUTATION IS  
 YOUR EXPERIENCE**

**SO # 602507**

**SERVICE ORDER  
 CUSTOMER COPY**



Status  
 Printed 07/31/2025 11:52:13 AM

User 1334 Page 4

<b>Customer No</b>		<b>Advisor</b> Nicole L	<b>Location</b>	<b>Promised</b> 05/01/2025 6:00 PM
Cariboo Railroad Contracting Corp. 3030 Pandosy Unit # #117 Kelowna, BC V1Y 0C4		<b>Shop</b> QL	<b>PO #</b>	<b>Opened</b> 05/01/2025 4:03 PM
		<b>Tag#</b> 7715	<b>UNIT 74</b>	<b>Cashiered</b> 05/01/2025 6:01 PM
<b>Home</b>	<b>Bus</b> (778) 478-1745	<b>License</b>	<b>Odom In</b>	<b>Odom Out</b>
<b>Cell</b>	<b>Today</b>	WV 7353	241078	241078
<b>Email</b>		<b>Year</b> 2018	<b>Make</b> CHEVROLET	<b>Model</b> SILVERADO 3500HD
	<b>Type</b>	<b>Vehicle ID No</b>	<b>Selling Dealer</b>	<b>Model Number</b> CK36043
	<b>Term Charge</b>	1GB4KYCG2JF246800		<b>Colour</b> WHITE
		<b>Engine</b> VORTEC 6.0L VARIABLE VALVE		<b>Delivery Date</b>
				72

CUSTOMER'S PREFERRED METHOD OF CONTACT:

TEXT \_\_\_\_\_ CALL \_\_\_\_\_ EMAIL \_\_\_\_\_

ENGINE HOURS \_\_\_\_\_

Would you like your used parts returned Yes / No (not applicable if warranty)

Labour	Description	Type	Amount
888	CUSTOMER INFORMATION/CONTACT# _____	CQL	0.00

CUSTOMER'S PREFERRED METHOD OF CONTACT:

TEXT \_\_\_\_\_ CALL \_\_\_\_\_ EMAIL \_\_\_\_\_

ENGINE HOURS \_\_\_\_\_

Would you like your used parts returned Yes / No (not applicable if warranty)

Technician 999 -

**TERMS: STRICTLY CASH UNLESS ARRANGEMENTS ARE MADE.** "I hereby authorize the repair work hereinafter to be done along with the necessary material and agree that you are not responsible for loss or damage to vehicle or articles left in the vehicle in case of fire, theft, or any other cause beyond your control or for any delays caused by unavailability of parts or delays in parts shipments by the supplier or transporter. I hereby grant you or your employees permission to operate the vehicle herein described on streets, highways, or elsewhere for the purpose of testing and/or inspection. An express mechanic's lien is hereby acknowledged on above vehicle to secure the amount of repairs thereto."

**DISCLAIMER OF WARRANTIES:** Any warranties on the products sold hereby are those made by the manufacturer. The seller hereby expressly disclaims all warranties either express or implied, including any implied warranty of merchantability or fitness for a particular purpose, and the seller neither assumes or authorizes any other person to assume for it any liability in connection with the sale of said products. Any limitation contained herein does not apply where prohibited by law.

**PRIVACY STATEMENT:** Personal information is collected in accordance with applicable privacy legislation and is governed by the Dealer's Privacy Policy. Your privacy is important to us. Ask us if you would like information about our Privacy Policy. We provide this personal information to Ford Motor Company of Canada Limited (together with third parties acting on its behalf "Ford") to enable Ford to administer your transaction, to provide you with services, to improve automotive related products and services by conducting customer surveys, and to provide you with marketing material which may be of interest to you. To obtain the Ford Privacy Policy or if you do not want to receive marketing or survey materials from Ford please call 1-800-565-FORD (3673).

**NO RETURN ON ELECTRICAL OR SAFETY ITEMS OR SPECIAL ORDERS**

**DISCLAIMER:** Wheel lug nuts must be retorqued 100km after any wheel has been removed. This is the CUSTOMERS responsibility.

Customer Signature: \_\_\_\_\_

GST# 10570 8457 RT0001

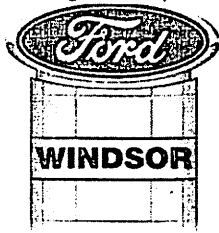

**WINDSOR FORD**  
 10001 139 Avenue • Grande Prairie, AB • T8X 0V3  
 Tel: (780) 532-9555 • 1-800-422-6094  
 service@windsorford.com • www.windsorford.com  
**SERVICE HOURS - Mon - Fri 7:30 A.M. - 6:00 P.M.**  
**Saturday - 8:00 A.M. - 5:00 P.M.**

**GENUINE PEOPLE  
 TREATING YOU LIKE  
 A PERSON**

**OUR REPUTATION IS  
 YOUR EXPERIENCE**

**SO # 602507**

Status  
 Printed 07/31/2025 11:52:13 AM

**SERVICE ORDER  
 CUSTOMER COPY**



User 1334 Page 5

<b>Customer No</b>	
LE	
Cariboo Railroad Contracting Corp.	
3030 Pandosy Unit # #117	
Kelowna, BC V1Y 0C4	
<b>Home</b>	<b>Bus</b> (778) 478-1745
<b>Cell</b>	<b>Today</b>
<b>Email</b>	
<b>Type</b>	
<b>Term Charge</b>	

<b>Advisor</b> Nicole L	<b>Location</b>	<b>Promised</b> 05/01/2025 6:00 PM
<b>Shop</b> QL	<b>PO #</b>	<b>Opened</b> 05/01/2025 4:03 PM
<b>Tag#</b> 7715	<b>UNIT 74</b>	<b>Cashiered</b> 05/01/2025 6:01 PM

License	Odom In	Odom Out	In Service Date	Stock No
WV 7353	241078	241078		
<b>Year</b> 2018	<b>Make</b> CHEVROLET	<b>Model</b> SILVERADO 3500HD	<b>Model Number</b> CK36043	<b>Colour</b> WHITE
<b>Vehicle ID No</b> 1GB4KYCG2JF246800	<b>Selling Dealer</b>	<b>Extended Warranty</b>	<b>Delivery Date</b>	
<b>Engine</b> VORTEC 6.0L VARIABLE VALVE		72		

Labour	62.50
Parts	61.14
Supplies	0.00
Env Fee	5.00
<b>Sub-Total</b>	<b>128.64</b>
GST	0.00
GST	6.43
<b>Total Invoice</b>	<b>135.07</b>

Customer Deductible	0.00
GST	0.00
<b>Customer Total</b>	<b>0.00</b>

<b>Third Party Billable</b>	<b>135.07</b>
Cariboo Railroad Contracting Corp. - CARIBOO CENTR1	

**Job Code:** Ab.Cargi.ver.bid  
**Equipment Unit #:** 74  
**Comment:**

*Tim Hawryluk*

**TERMS: STRICTLY CASH UNLESS ARRANGEMENTS ARE MADE.** "I hereby authorize the repair work hereinafter to be done along with the necessary material and agree that you are not responsible for loss or damage to vehicle or articles left in the vehicle in case of fire, theft, or any other cause beyond your control or for any delays caused by unavailability of parts or delays in parts shipments by the supplier or transporter. I hereby grant you or your employees permission to operate the vehicle herein described on streets, highways, or elsewhere for the purpose of testing and/or inspection. An express mechanic's lien is hereby acknowledged on above vehicle to secure the amount of repairs thereto."

**DISCLAIMER OF WARRANTIES:** Any warranties on the products sold hereby are those made by the manufacturer. The seller hereby expressly disclaims all warranties either express or implied, including any implied warranty of merchantability or fitness for a particular purpose, and the seller neither assumes or authorizes any other person to assume for it any liability in connection with the sale of said products. Any limitation contained herein does not apply where prohibited by law.

**PRIVACY STATEMENT:** Personal information is collected in accordance with applicable privacy legislation and is governed by the Dealer's Privacy Policy. Your privacy is important to us. Ask us if you would like information about our Privacy Policy. We provide this personal information to Ford Motor Company of Canada Limited (together with third parties acting on its behalf "Ford") to enable Ford to administer your transaction, to provide you with services, to improve automotive related products and services by conducting customer surveys, and to provide you with marketing material which may be of interest to you. To obtain the Ford Privacy Policy or if you do not want to receive marketing or survey materials from Ford please call 1-800-565-FORD (3673).

**NO RETURN ON ELECTRICAL OR SAFETY ITEMS OR SPECIAL ORDERS**

**DISCLAIMER:** Wheel lug nuts must be retorqued 100km after any wheel has been removed. This is the CUSTOMERS responsibility.

Customer Signature: \_\_\_\_\_

GST# 10570 8457 RT0001

KBT VENTURES LTD  
3032 RECPLACE DRIVE  
PRINCE GEORGE, BC V2N 0G2  
(236) 423-4215  
www.mrlube.com

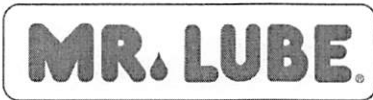

Date	08-Mar-2025 3:50 PM
Invoice #	23560097
Transaction #	25030823560097
License Plate	BC-WJ8879

Customer Information	Vehicle Information
CONTRACT CARIBOO RAILROAD 209-307 BANKS RD Kelowna, BC V1X 6A1 (778) 478-1745	KILOMETERS 188541 2021 GMC Sierra 3500 HD SLE 8Cyl 6.6L 403 MFI OHV DIESEL Turbo L5P 445hp Duramax (Y) VIN 1GT49TEYXMF139322

Fleets	Service History						
RCARCEN N CARIBOO RAILROAD CONTRACTING	<table border="1"> <thead> <tr> <th>DATE</th> <th>KILOMETERS</th> <th>SERVICES</th> </tr> </thead> <tbody> <tr> <td>08-Mar-2025</td> <td>188541</td> <td>OC4 WW AF</td> </tr> </tbody> </table>	DATE	KILOMETERS	SERVICES	08-Mar-2025	188541	OC4 WW AF
DATE	KILOMETERS	SERVICES					
08-Mar-2025	188541	OC4 WW AF					

Description	QTY	Price
PREMIUM SYN DIESEL PKG	1.00	164.99
SHOP SUPPLIES	1.00	5.99
COURTESY CHECK	1.00	0.00
OIL FILTER S11878/PH26	1.00	0.00
SPECIAL FILTER CHARGE \$9	1.00	9.00
MOBIL DELVAC 1 5W40 ESP	9.50	0.00
TIRE PRESSURE IS ===>	60.80	0.00
FACTORY SEALED VEHICLE	1.00	0.00
FREE WASHER FLUID TOP-UP	1.00	0.00
WINTER WASHER FLUID BULK	1.00	0.00
BATTERY TEST PASSED	1.00	0.00
AIR FILTER LAF9248	1.00	59.99
SERVICE FRONT AND REAR DIFFERENTIALS SOON	1.00	0.00
SERVICE TRANSFER CASE SOON		
SCREW MISSING ON AIR BOX		
DRIVER SIDE AXLE SEAL SWEAT		
SALE		\$239.97
TAXABLE	239.97	
PST		16.80
GST #71704-3913		12.00
<b>TOTAL</b>		<b>\$268.77</b>
CHARGE		268.77

X  
I have agreed to the information contained on this invoice.

**Messages**  
THANKS FOR CHOOSING US WE LOOK FOWARD TO YOUR RETURN WE OFFER FUEL SYSTEM CLEANING,DRIVE SAFE THANK YOU

**Recommend next service on 06-Jun-2025 or 193541 km.**

**Employees**

UPPER	LOWER	COURTESY	TIRE
MARLEY	TANNER	MARLEY	

**Warranty Approved Service**

At Mr. Lube, oil changes are warranty-approved and Mr. Lube precisely follows the service intervals and product specifications your vehicle's manufacturer recommends for the exact make, model and year of your car.

# Complete our survey and receive a chance to WIN!

- ✓ Win a FREE oil change weekly
- ✓ Receive 10 chances to win \$1,000 daily\*
- ✓ You could instantly win other great prizes valued at \$1,500 weekly\*

## We value your feedback.

Rate us at [www.tellmrlube.com](http://www.tellmrlube.com), or call 1-866-681-4932 and you could win a free oil change weekly!

**PLUS** receive a chance to win daily cash and other great prizes by visiting [tellmrlube.com](http://tellmrlube.com) or calling 1-866-681-4932

<b>Survey Code:</b> 184GV197WJ
-----------------------------------

Enter this code at [tellmrlube.com](http://tellmrlube.com)

\*Check inmoment.com for contest details. © Reg. TM/MD of ML Royalties Limited Partnership, used under license.

KBT VENTURES LTD  
3032 RECPLACE DRIVE  
PRINCE GEORGE, BC V2N 0G2  
(236) 423-4215  
www.mrlube.com

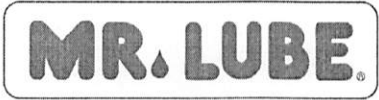

Date	08-Mar-2025 3:50 PM
Invoice #	23560097
Transaction #	25030823560097
License Plate	BC-WJ8879

**Courtesy Checklist**

**COURTESY CHECK / DOUBLE CHECK**

<b>CHECKS:</b>		-Transfer Case/PTU Fluid Level	RECOMMEND REPLACING
-Washer Fluid	TOPUP	-Differential Fluid Level - Front	RECOMMEND REPLACING
-Coolant Fluid	LEVEL OK	-Lights	CHECKED OK
-Power Steering Fluid	LEVEL OK	-Leaks (Fluid, Oil)	APPEARS OK
-Serpentine Belt	NO CHECK	TIRE SERVICE CHECKS:	
-Air Filter	REPLACED	-Tire Pressure	TIRE PRESSURE OK
-Cabin Air Filter	NO CHECK	DOUBLE CHECKS:	
-Battery	NO CHECK	-Oil Pan Drain Plug	CHECK
-Wash Windows	COMPLETED	-Oil Filter	CHECK
-Wiper Blades Front/Rear	APPEARS OK	-Front Differential Plug	CHECK
-Windshield	APPEARS OK	-Transfer Case/PTU Plug	CHECK
-Transmission/Transaxle Fluid	LEVEL OK	-Rear Differential Plug	CHECK
-Differential Fluid Level - Rear	RECOMMEND REPLACING		

**DISCLAIMER**

KBT VENTURES LTD is the "Operator" of this Mr. Lube Store. BE ADVISED that the courtesy checks provided in connection with the servicing of your vehicle are provided solely as a courtesy and for your information only. The Operator does not represent or warrant that the courtesy checks are in any way comprehensive or that the results of the courtesy checks are accurate. The Operator disclaims any and all responsibility for ensuring that your vehicle is in proper working condition with respect to the parts, components or matters inspected or reviewed in the courtesy checks or that it is safe for you or any other person to operate. In no event will the Operator or any of its directors, officers, employees, agents or representatives be liable in any way for any loss or damage whatsoever (including personal injury or death) resulting or arising from, or in any way connected with, any failure of any of the parts, components or matters inspected or reviewed in the courtesy checks.

Job Code: BCCN.FC2.HR  
Equipment Unit #: Unit 74  
Comment:

*Tim Hawryluk*

# Complete our survey and receive a chance to WIN!

- ✓ Win a FREE oil change weekly
- ✓ Receive 10 chances to win \$1,000 daily\*
- ✓ You could instantly win other great prizes valued at \$1,500 weekly\*

**We value your feedback.**

Rate us at [www.tellmrlube.com](http://www.tellmrlube.com), or call 1-866-681-4932 and you could win a free oil change weekly!

**PLUS** receive a chance to win daily cash and other great prizes by visiting [tellmrlube.com](http://tellmrlube.com) or calling 1-866-681-4932

**Survey Code:**  
184GV197WJ

Enter this code at [tellmrlube.com](http://tellmrlube.com)

\*Check inmoment.com for contest details. © Reg. TM/MD of ML Royalties Limited Partnership, used under license.



**K. P. ABERNATHY LTD.**  
 3205 McLennan Road  
 Box 218, Valemount V0E2Z0  
 Tel. (250) 566-9131  
 Fax (250) 566-9132

**INVOICE #**  
 028164

ESTIMATE#	48748
P.O. #	BCCNFC2HR
DATE	January 28 2025

Advisor : Cheryl Ann

<b>CUSTOMER :</b> Cariboo Railroad Contracting Corp 117-3030 Pandosy Street Kelowna BC V1Y 0C4	Work: (778) 478-1745 Res. : (780) 499-4205 Cel. : ( ) - - Fax. : (778) 478-1746	<b>VEHICLE :</b> 74 <b>MAKE :</b> <b>MODEL :</b> <b>YEAR :</b> <b>VIN # :</b> <b>LICENSE :</b> <b>COLOUR :</b>	<b>EXIT KM:</b> 0 <b>CYLINDERS :</b> <b>ENGINE :</b>
--	--	--	--

PART NO	DESCRIPTION	QTY	UNIT \$	%	PARTS	LABOUR
00000LAB	<b>LABOUR (FP)</b> Oil Service	1	120.00			120.00
66GFEC1540J	66 Guardol Fleet EC 15W40 Jug 3.785L	2	26.92		53.84	
ENVOOILJUG	Environmental & Container Fee	2	0.90		1.80	
66GFEC1540	66 Guardol Fleet oil EC 15W40 946 ml	2	7.95		15.90	
ENVIROOIL	Environmental & Container Fee 946 ml-1L	2	0.17		0.34	
***** \$191.88 *****						

RE-TORQUE WHEELS AFTER 150 KM

Job Code: BC.CN.FC2HR

Task Code: A16NB

Equipment Unit #: 74

Comment: LOF

*Tammy Froelich*

Jan 28, 2025

Rec Jan 28/25

		SUB-TOTAL	\$71.88	\$120.00
<b>LEGAL WARRANTY</b>		SUB-TOTAL		\$191.88
Warranty parts must be returned with original invoice. Credit will be given after manufacturer inspection. Warranty period varies on all parts.				
<b>PAYMENTS</b>		GST	102-880-101	\$9.59
RECEIVABLES	214.90	PST	1002-7809	\$13.43
		TOTAL		\$0.00
				\$214.90

SALES BY CREDIT : Payable upon receipt of account statement. Administration fees will be charged on all outstanding balances at a rate of 2% per month (24% yearly). All merchandise sold remains the property of the seller until full payment has been received. The customer's signature below confirms he/she has taken knowledge of, and accepts, all terms and conditions. I hereby authorize the opening and keeping of a maintenance and repair file and I also hereby authorize the repair shop and his employees to collect use and communicate to any third party any personal or other information which is necessary to the constitution of the file. I further authorize the repair shop and his employees to use said information for commercial purposes. Moreover, I hereby authorize the repair work herein set forth and the use of the material necessary to the completion of said repair work. To the extent permitted by law, you are not responsible for loss or damage to the vehicle or articles left in vehicle in case of fire, theft or any other cause beyond your control or for any delays caused by the unavailability of parts or delays in the shipment of parts by the supplier or transporter. I hereby grant you and your employees permission to operate the vehicle herein described on streets, highway or elsewhere for the purpose of testing on inspection

Date: \_\_\_\_\_ Customer's signature : \_\_\_\_\_

KAL TIRE  
713 SWITZER DR  
HINTON, AB  
T7V 1V1  
Phone: 780-865-4547  
Fax: 780-865-4942



Invoice #: 082369846  
Order Date: Oct 15 2024  
Completed Date: Nov 05 2024  
Page: 1  
Team Member: RGOBEIL

CARIBOO RAILROAD CONT CORP  
307 BANKS ROAD  
UNIT 209  
KELOWNA, BC  
V1X 6A1

CARIBOO RAILROAD CONT CORP  
307 BANKS ROAD  
UNIT 209  
KELOWNA, BC  
V1X 6A1  
Phone: (778) 478-1745

Account: GST/HST: 122644537

PO #: 74

Year: 2021  
Make: GMC  
Model: SIERRA 3500  
Unit: 74  
Lic #: RD5962  
Prov: BC  
VIN: 1GT49TEYXMF139322  
Mi/KM: 172303

Qty	Product Code	Description	Price	Unit	Amount
1	SEAD10L 9.50	10L BASIC INSPEC SERV-DIESEL	139.10	EA	139.10
1	WL10454	OIL FILTER	N/C	PCS	N/C
4	EHCF	ENVIRO HANDLING FEE-OIL FILTER	0.55	PCS	2.20
18.96	500010133	SHELL ROTELLA T6 5W40 BULK FULL SYN	N/C	LTR	N/C
18	EHCO	ENVIRO HANDLING FEE - OIL	0.35	PCS	6.30
0.50	MLH	AIR CLEANER ELEMENT - R&R	158.00	HR	79.00
Diesel Includes: Reset Air Cleaner Monitor., FUEL INJECTION - ELECTRONIC, DIESEL					
1	RES	RESET OIL LIFE MONITOR IF EQUI	N/C	EA	N/C
0.40	MLH	CABIN AIR FILTER - R&R	158.00	HR	63.20
All Applicable Model					
1	24211	CABIN AIR WITH BIOSHIELD	67.96	PCS	67.96
1	507001	AIR FILTERS	43.78	TAG	43.78
AG1238659642 WIX WA11057 AIR FILTER					

Registration Information

Registered Owner CARIBOO RAILROAD CONT CORP  
Registered Address 307 BANKS ROAD  
UNIT 209  
KELOWNA BC V1X 6A1  
CAN

Additional Mandatory Items

AUTHORIZED BY: DISPATCH

DRIVERS NAME: TONY CRESSMAN

Tire Position(s)

N/A

KAL TIRE  
713 SWITZER DR  
HINTON, AB  
T7V 1V1  
Phone: 780-865-4547  
Fax: 780-865-4942



Invoice #: 082369846  
Order Date: Oct 15 2024  
Completed Date: Nov 05 2024  
Page: 2  
Team Member: RGOBEIL

Job Code: BC.CN.FC2.HR

Task Code: A16NB

Equipment Unit #: 74

Comment: LOF, FILTERS

*Tammy Froelich*

Nov 12, 2024

Rec Nov 08/24

I AM THE PERSON WHO REQUESTED THAT THE ABOVE WORK BE DONE AND MATERIAL SUPPLIED, OR I AM THE AUTHORIZED AGENT FOR THAT PERSON/COMPANY. I ACKNOWLEDGE INDEBTEDNESS FOR THE WORK DONE AND MATERIALS SUPPLIED IN THE AMOUNT OF \$421.62 , BEING THE TOTAL AMOUNT OWING AS SHOWN HEREON, OR IN THE AMOUNT OF ANY CHEQUE OR CREDIT CARD GIVEN IN PAYMENT AND LATER DISHONoured. TITLE TO THE GOODS DOES NOT TRANSFER UNTIL PAYMENT IS RECEIVED IN FULL FOR SAID GOODS.

Agreed Terms: NET 30  
interest of 16% per Annum Payable on Overdue Accounts.

Preferred payment method: Electronic Funds Transfer (EFT)  
Email paymentinfo@kaltire.com for details  
Cheque Payment: Send to Kal Tire Vernon Office: PO Box 1240, Vernon BC V1T 6N6

Subtotal	401.54
AB GST/HST	20.08
Total	421.62
Balance	421.62

IF WE SELL IT... WE GUARANTEE IT! WE WELCOME YOUR COMMENTS! CALL US WEEKDAYS AT 8AM TO 5PM (PACIFIC TIME) AT 1-800-663-9350 OR EMAIL US AT CUSTOMERSERVICE@KALTIRE.COM

KAL TIRE  
5959 3 AVE  
EDSON, AB  
T7E 1R8  
Phone: 780-712-7540  
Fax: 780-712-6105



Invoice #: 610218835  
Order Date: Jul 29 2024  
Completed Date: Jul 29 2024  
Page: 1  
Team Member: RORCINE

CARIBOO RAILROAD CONT CORP  
307 BANKS ROAD  
JNIT 209  
KELOWNA, BC  
V1X 6A1

CARIBOO RAILROAD CONT CORP  
307 BANKS ROAD  
UNIT 209  
KELOWNA, BC  
V1X 6A1  
Phone: (778) 478-1745

Account: GST/HST: 122644537

PO #: ABCNFC2HR

Year: 2021  
Make: GMC  
Model: SIERRA 3500  
Unit: 74  
Lic #: RD5962  
Prov: AB  
VIN: 1GT49TEYXMF139322  
Mi/KM: 160326

Qty	Product Code	Description	Price	Unit	Amount
2	45062	275/70R18 E10 BFG AT KO2 RWL	421.95	PCS	843.90
		BOTH FRONTS - SCRAP TAKEOFFS			
2	ABLEVY1	ALBERTA TIRE RECYCLING FEE	4.00	EA	8.00
2	PLTINST	PASS/LT INSTALL/BALANCE	33.00	EA	66.00
1	TRQC	*YOUR WHEELS HAVE BEEN TORQUED	N/C	EA	N/C
1	SEAG8L	8L BASIC INSPEC/OIL SERV-GAS	89.01	EA	89.01
1	SUG8L	8L PLATINUM UPGRADE-SYNTHETIC	70.95	EA	70.95
8.00	500005376	PZL PLATINUM FULL SYN 5W30 - BULK	N/C	LTR	N/C
1	EHCO	ENVIRO HANDLING FEE - OIL	0.35	PCS	0.35
1	100454	OIL FILTER	N/C	PCS	N/C
1	EHCF	ENVIRO HANDLING FEE-OIL FILTER	0.55	PCS	0.55

Registration Information

Registered Owner CARIBOO RAILROAD CONT CORP  
Registered Address 307 BANKS ROAD  
UNIT 209  
KELOWNA BC V1X 6A1  
CAN

Additional Mandatory Items

AUTHORIZED BY: TAMMY

DRIVERS NAME: TONY

Tire Position(s)

\_F, RF

KAL TIRE  
5959 3 AVE  
EDSON, AB  
T7E 1R8  
Phone: 780-712-7540  
Fax: 780-712-6105



Invoice #: 610218835  
Order Date: Jul 29 2024  
Completed Date: Jul 29 2024  
Page: 2  
Team Member: RORCINE

Job Code: BC.CN.FC2.HR

Task Code: A16NB

Equipment Unit #: 74

Comment: LOF, TIRES. DID NOT APPROVE THOSE TIRES

DocuSigned by:  
*Tammy Froelich*  
C2DEEF0C9EDD4F2...

2024-08-06

Rec Aug 1/24

I AM THE PERSON WHO REQUESTED THAT THE ABOVE WORK BE DONE AND MATERIAL SUPPLIED, OR I AM THE AUTHORIZED AGENT FOR THAT PERSON/COMPANY. I ACKNOWLEDGE INDEBTEDNESS FOR THE WORK DONE AND MATERIALS SUPPLIED IN THE AMOUNT OF \$1,132.70 , BEING THE TOTAL AMOUNT OWING AS SHOWN HEREON, OR IN THE AMOUNT OF ANY CHEQUE OR CREDIT CARD GIVEN IN PAYMENT AND LATER DISHONOURED. TITLE TO THE GOODS DOES NOT TRANSFER UNTIL PAYMENT IS RECEIVED IN FULL FOR SAID GOODS.

Subtotal	1,078.76
AB GST/HST	53.94
Total	1,132.70
Balance	1,132.70

Agreed Terms: NET 30  
interest of 16% per Annum Payable on Overdue Accounts.

Preferred payment method: Electronic Funds Transfer (EFT)  
Email paymentinfo@kaltire.com for details  
Cheque Payment: Send to Kal Tire Vernon Office: PO Box 1240, Vernon BC V1T 6N6

IF WE SELL IT... WE GUARANTEE IT! WE WELCOME YOUR COMMENTS! CALL US WEEKDAYS AT 8AM TO 5PM (PACIFIC TIME) AT 1-800-663-9350 OR EMAIL US AT CUSTOMERSERVICE@KALTIRE.COM



**GMC : 1500/2500/3500 (Sierra/C-K Series 1999- ) : 3500 4X4 : 2021 : Crew Cab : Standard Bed  
(158.9" Wheelbase)  
Thrust Line Alignment**

**Current Measurements**

**Left Front**

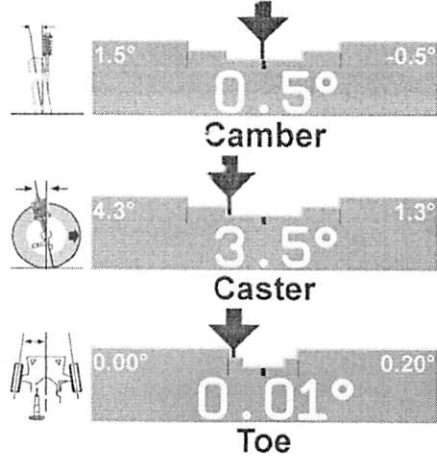

**Right Front**

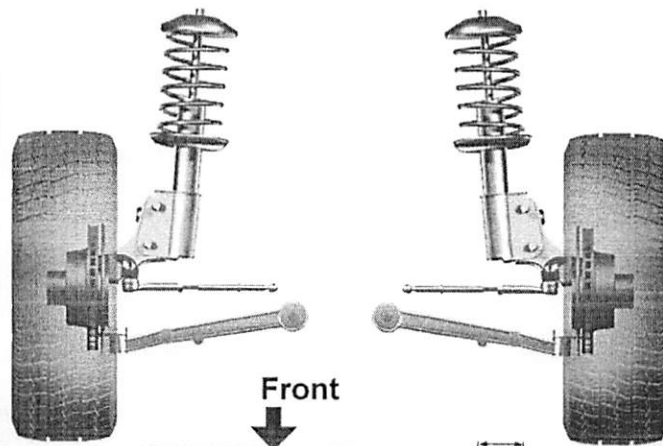
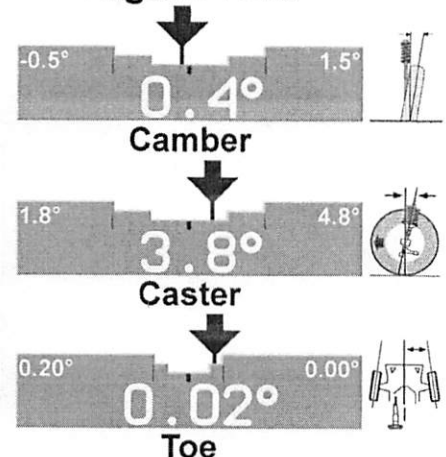

**Front**

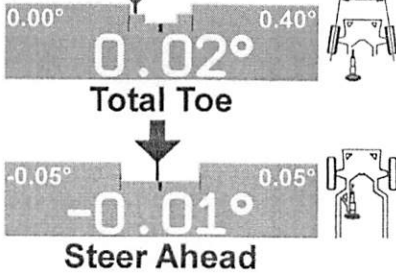

**Left Rear**

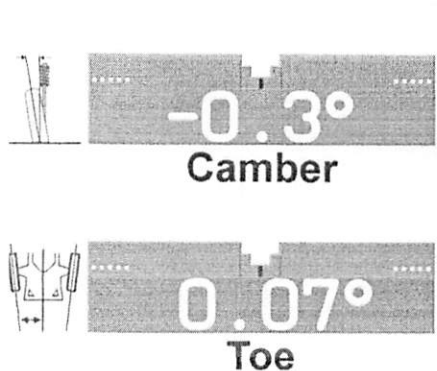

**Right Rear**

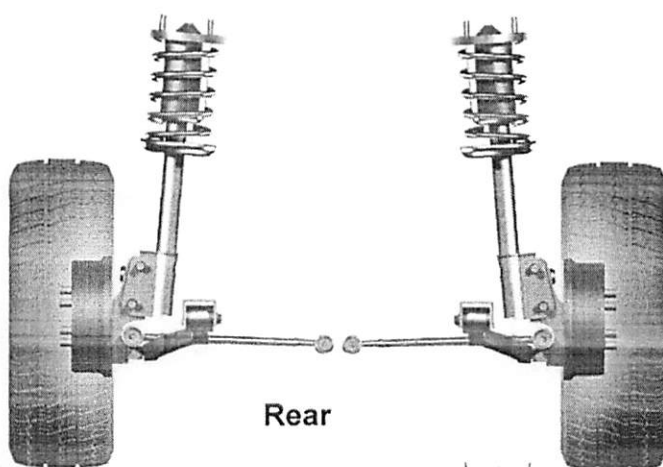
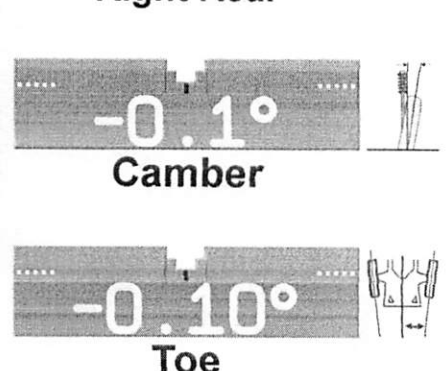

**Rear**

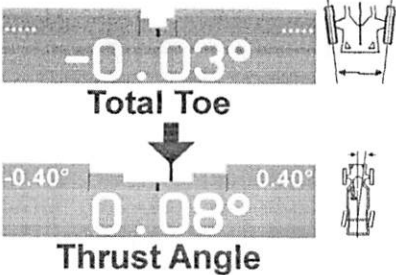

RC Partnership Ltd.  
821 Parsons Road SW  
EDMONTON, AB T6X 0B4  
(780) 466-5866  
www.mrlube.com

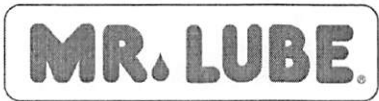

Date	03-Mar-2024 12:28 PM
Invoice #	13417712
Transaction #	24030313417712
License Plate	BC-RD5962

<b>Customer Information</b>		<b>Vehicle Information</b>																																																										
CARIBOO CENTRAL RAILROAD Kelowna, BC V1X 4H8 (250) 612-7010		KILOMETERS 137537 2021 GMC TRUCKS SIERRA 3500 PICKUP 8cyl 6.6L Diesel Turbo VIN 1GT49TEYXMF139322																																																										
<b>Fleets</b>		<b>Service History</b>																																																										
RCARCEN N CARIBOO RAILROAD CONTRACTING		<table border="1"> <thead> <tr> <th>DATE</th> <th>KILOMETERS</th> <th>SERVICES</th> </tr> </thead> <tbody> <tr> <td>03-Mar-2024</td> <td>137537</td> <td>OC1 WW DFF DEF</td> </tr> <tr> <td>18-Aug-2023</td> <td>112714</td> <td>OC1 LUB G9 WW</td> </tr> <tr> <td>27-May-2023</td> <td>99582</td> <td>OC1 WW AF DFF</td> </tr> <tr> <td>08-Nov-2022</td> <td>69406</td> <td>OC1 LUB G11 WW AF WB</td> </tr> <tr> <td>22-Aug-2022</td> <td>58666</td> <td>OC1 LUB G9 WW AF CAB DFF</td> </tr> <tr> <td>04-Jul-2022</td> <td>48546</td> <td>OC1 LUB G7 WW</td> </tr> <tr> <td>27-Jan-2022</td> <td>40407</td> <td>OC1 LUB G9 WW</td> </tr> </tbody> </table>		DATE	KILOMETERS	SERVICES	03-Mar-2024	137537	OC1 WW DFF DEF	18-Aug-2023	112714	OC1 LUB G9 WW	27-May-2023	99582	OC1 WW AF DFF	08-Nov-2022	69406	OC1 LUB G11 WW AF WB	22-Aug-2022	58666	OC1 LUB G9 WW AF CAB DFF	04-Jul-2022	48546	OC1 LUB G7 WW	27-Jan-2022	40407	OC1 LUB G9 WW																																	
DATE	KILOMETERS	SERVICES																																																										
03-Mar-2024	137537	OC1 WW DFF DEF																																																										
18-Aug-2023	112714	OC1 LUB G9 WW																																																										
27-May-2023	99582	OC1 WW AF DFF																																																										
08-Nov-2022	69406	OC1 LUB G11 WW AF WB																																																										
22-Aug-2022	58666	OC1 LUB G9 WW AF CAB DFF																																																										
04-Jul-2022	48546	OC1 LUB G7 WW																																																										
27-Jan-2022	40407	OC1 LUB G9 WW																																																										
<p>X</p> <p>I have agreed to the information contained on this invoice.</p>		<table border="1"> <thead> <tr> <th>Description</th> <th>QTY</th> <th>Price</th> </tr> </thead> <tbody> <tr> <td>SELECT DIESEL PACKAGE</td> <td>1.00</td> <td>144.99</td> </tr> <tr> <td>SHOP SUPPLIES</td> <td>1.00</td> <td>7.99</td> </tr> <tr> <td>COURTESY CHECK</td> <td>1.00</td> <td>0.00</td> </tr> <tr> <td>OIL FILTER PH26</td> <td>1.00</td> <td>0.00</td> </tr> <tr> <td>SPECIAL FILTER CHARGE \$6</td> <td>1.00</td> <td>6.00</td> </tr> <tr> <td>MOBIL DELVAC 1300 15W40</td> <td>9.50</td> <td>0.00</td> </tr> <tr> <td>TIRE PRESSURE IS ==&gt;</td> <td>35.35</td> <td>0.00</td> </tr> <tr> <td>FACTORY SEALED VEHICLE</td> <td>1.00</td> <td>0.00</td> </tr> <tr> <td>FREE WASHER FLUID TOP-UP</td> <td>1.00</td> <td>0.00</td> </tr> <tr> <td>WINTER WASHER FLUID BULK</td> <td>1.00</td> <td>0.00</td> </tr> <tr> <td>BATTERY TEST PASSED</td> <td>1.00</td> <td>0.00</td> </tr> <tr> <td>DIESEL FUEL FILTER L9999F</td> <td>1.00</td> <td>179.99</td> </tr> <tr> <td>DIESEL EXHAUST FLUID 10L</td> <td>1.00</td> <td>34.99</td> </tr> <tr> <td>REMAINING LITRES TO CUST.</td> <td>5.00</td> <td>0.00</td> </tr> <tr> <td>SALE</td> <td></td> <td>\$373.96</td> </tr> <tr> <td>831770441-RT0001</td> <td></td> <td>18.70</td> </tr> <tr> <td><b>TOTAL</b></td> <td></td> <td><b>\$392.66</b></td> </tr> <tr> <td>CHARGE</td> <td></td> <td>392.66</td> </tr> </tbody> </table>		Description	QTY	Price	SELECT DIESEL PACKAGE	1.00	144.99	SHOP SUPPLIES	1.00	7.99	COURTESY CHECK	1.00	0.00	OIL FILTER PH26	1.00	0.00	SPECIAL FILTER CHARGE \$6	1.00	6.00	MOBIL DELVAC 1300 15W40	9.50	0.00	TIRE PRESSURE IS ==>	35.35	0.00	FACTORY SEALED VEHICLE	1.00	0.00	FREE WASHER FLUID TOP-UP	1.00	0.00	WINTER WASHER FLUID BULK	1.00	0.00	BATTERY TEST PASSED	1.00	0.00	DIESEL FUEL FILTER L9999F	1.00	179.99	DIESEL EXHAUST FLUID 10L	1.00	34.99	REMAINING LITRES TO CUST.	5.00	0.00	SALE		\$373.96	831770441-RT0001		18.70	<b>TOTAL</b>		<b>\$392.66</b>	CHARGE		392.66
Description	QTY	Price																																																										
SELECT DIESEL PACKAGE	1.00	144.99																																																										
SHOP SUPPLIES	1.00	7.99																																																										
COURTESY CHECK	1.00	0.00																																																										
OIL FILTER PH26	1.00	0.00																																																										
SPECIAL FILTER CHARGE \$6	1.00	6.00																																																										
MOBIL DELVAC 1300 15W40	9.50	0.00																																																										
TIRE PRESSURE IS ==>	35.35	0.00																																																										
FACTORY SEALED VEHICLE	1.00	0.00																																																										
FREE WASHER FLUID TOP-UP	1.00	0.00																																																										
WINTER WASHER FLUID BULK	1.00	0.00																																																										
BATTERY TEST PASSED	1.00	0.00																																																										
DIESEL FUEL FILTER L9999F	1.00	179.99																																																										
DIESEL EXHAUST FLUID 10L	1.00	34.99																																																										
REMAINING LITRES TO CUST.	5.00	0.00																																																										
SALE		\$373.96																																																										
831770441-RT0001		18.70																																																										
<b>TOTAL</b>		<b>\$392.66</b>																																																										
CHARGE		392.66																																																										
<b>Messages</b>																																																												
WE NOW OFFER ALL TIRE SERVICES; NEW TIRE SALES, REPAIR, SEASONAL SWAP, EVEN TIRE STORAGE-SEE US FOR TIRES WE ALSO OFFER POWER STEERING FLUSH SERVICE! RECOMMENDED EVERY 80,000KMS																																																												
<b>Recommend next service on 01-Jun-2024 or 145537 km.</b>																																																												
<b>Employees</b>																																																												
UPPER	LOWER	COURTESY																																																										
INDER	HARMAN	KUMAR																																																										
<b>Service Comments</b>																																																												
THANK YOU AND DRIVE CAREFULLY THANK YOU, SEE YOU IN 5000 KM RETURN FOR NO CHARGE INSPECT.																																																												
<b>Warranty Approved Service</b>																																																												

At Mr. Lube, oil changes are warranty-approved and Mr. Lube precisely follows the service intervals and product specifications your vehicle's manufacturer recommends for the exact make, model and year of your car.

Job Code: BC.CN.FC2.HR

Task Code: A16NB

Equipment Unit #: 74

Comment: LOF

DocuSigned by:  
*Tammy Froelich*  
C2DEEF0C9EDD4F2...  
2024-03-11

Rec Mar 03/24

# Complete our survey and receive a chance to WIN!

- ✓ Win a FREE oil change weekly
- ✓ Receive 10 chances to win \$1,000 daily\*
- ✓ You could instantly win other great prizes valued at \$1,500 weekly\*

## We value your feedback.

Rate us at [www.tellmrlube.com](http://www.tellmrlube.com), or call 1-866-681-4932 and you could win a free oil change weekly!

PLUS receive a chance to win daily cash and other great prizes by visiting [tellmrlube.com](http://tellmrlube.com) or calling 1-866-681-4932

Survey Code:  
**16KRCRK1X2**

Enter this code at [tellmrlube.com](http://tellmrlube.com)

\*Check inmoment.com for contest details. © Reg. TM/MD of ML Royalties Limited Partnership, used under license.

RC Partnership Ltd.  
821 Parsons Road SW  
EDMONTON, AB T6X 0B4  
(780) 466-5866  
www.mrlube.com



Date	03-Mar-2024 12:28 PM
Invoice #	13417712
Transaction #	24030313417712
License Plate	BC-RD5962

**Courtesy Checklist**

**COURTESY CHECK / DOUBLE CHECK**

CHECKS:		-Windshield	APPEARS OK
-Washer Fluid	TOPUP	-Transmission/Transaxle Fluid	LEVEL OK
-Coolant Fluid	LEVEL OK	-Lights	CHECKED OK
-Power Steering Fluid	LEVEL OK	-Leaks (Fluid, Oil)	APPEARS OK
-Serpentine Belt	APPEARS OK	TIRE SERVICE CHECKS:	
-Air Filter	APPEARS OK	-Tire Pressure	TIRE PRESSURE OK
-Cabin Air Filter	APPEARS OK	DOUBLE CHECKS:	
-Battery	PASS	-Oil Pan Drain Plug	CHECK
-Wash Windows	COMPLETED	-Oil Filter	CHECK
-Wiper Blades Front/Rear	APPEARS OK	-Oil Light Reset	RESET

**DISCLAIMER**

RC Partnership Ltd. is the "Operator" of this Mr. Lube Store. BE ADVISED that the courtesy checks provided in connection with the servicing of your vehicle are provided solely as a courtesy and for your information only. The Operator does not represent or warrant that the courtesy checks are in any way comprehensive or that the results of the courtesy checks are accurate. The Operator disclaims any and all responsibility for ensuring that your vehicle is in proper working condition with respect to the parts, components or matters inspected or reviewed in the courtesy checks or that it is safe for you or any other person to operate. In no event will the Operator or any of its directors, officers, employees, agents or representatives be liable in any way for any loss or damage whatsoever (including personal injury or death) resulting or arising from, or in any way connected with, any failure of any of the parts, components or matters inspected or reviewed in the courtesy checks.

# Complete our survey and receive a chance to WIN!

- ✓ Win a FREE oil change weekly
- ✓ Receive 10 chances to win \$1,000 daily\*
- ✓ You could instantly win other great prizes valued at \$1,500 weekly\*

**We value your feedback.**

Rate us at [www.tellmrlube.com](http://www.tellmrlube.com), or call 1-866-681-4932 and you could win a free oil change weekly!

**PLUS** receive a chance to win daily cash and other great prizes by visiting [tellmrlube.com](http://tellmrlube.com) or calling 1-866-681-4932

**Survey Code:**  
**16KRCRK1X2**

Enter this code at [tellmrlube.com](http://tellmrlube.com)

\*Check inmoment.com for contest details. ® Reg. TM/MD of ML Royalties Limited Partnership, used under license.

KAL TIRE  
 3050 49 AVE  
 RED DEER, AB  
 T4P 2V7  
 Phone: 403-347-8851  
 Fax: 403-342-0548



L  
 Invoice #: 092476315  
 Order Date: Jan 31 2023  
 Completed Date: Feb 02 2023  
 Page: 1  
 Team Member: LDEETJEN

CARIBOO CENTRAL RAILROAD CONTR  
 307 BANKS ROAD  
 JNIT 209  
 KELOWNA, BC  
 V1X 6A1

CARIBOO CENTRAL RAILROAD CONTR  
 307 BANKS ROAD  
 UNIT 209  
 KELOWNA, BC  
 V1X 6A1  
 Phone: (778) 478-1745

Account: GST/HST: 122644537

PO #: 74  
 Year: 2021  
 Make: GMC  
 Model: SIERRA 3500  
 Unit: 74  
 Lic #: RD5962  
 Prov: BC  
 VIN: 1GT49TEYXMF139322  
 Mi/KM: 79077

Qty	Product Code	Description	Price	Unit	Amount
4	004377	275/70R18 E10 FST DEST XT 125S	414.93	PCS	1,659.72
4	ABLEVY1	ALBERTA TIRE RECYCLING FEE	4.00	EA	16.00
4	LINST	LIGHT TRK TIRE INSTAL & BALANC	20.00	EA	80.00
1	TRQC	*YOUR WHEELS HAVE BEEN TORQUED	N/C	EA	N/C
1	SEID10L	10L BASIC INSPEC SERV-DIESEL	125.00	EA	125.00
1	SUDS10L	10L SYNTHETIC UPGRADE DIESEL	65.00	EA	65.00
1	100454	OIL FILTER	N/C	PCS	N/C
3	EHCF	ENVIRO HANDLING FEE-OIL FILTER	0.55	PCS	1.65
10.00	500010133	SHELL ROTELLA T6 5W40 BULK FULL SYN	N/C	LTR	N/C
10	EHCO	ENVIRO HANDLING FEE - OIL	0.20	PCS	2.00
	9.46L				

Registration Information

Registered Owner CARIBOO CENTRAL RAILROAD CONTR  
 Registered Address 307 BANKS ROAD  
 UNIT 209  
 KELOWNA BC V1X 6A1  
 CAN

Additional Mandatory Items

AUTHORIZED BY: TAMMY

DRIVERS NAME: TONY

Tire Position(s)

N/A

KAL TIRE  
3050 49 AVE  
RED DEER, AB  
T4P 2V7  
Phone: 403-347-8851  
Fax: 403-342-0548



L  
Invoice #: 092476315  
Order Date: Jan 31 2023  
Completed Date: Feb 02 2023  
Page: 2  
Team Member: LDEETJEN

Job Code: Mech22  
Task Code: Unit 74  
Equipment Unit #: 74  
Comment: Na

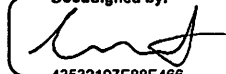
DocuSigned by:  
  
43532197E88E466...  
2023-02-03

Rec Feb 02/23

I AM THE PERSON WHO REQUESTED THAT THE ABOVE WORK BE DONE AND MATERIAL SUPPLIED, OR I AM THE AUTHORIZED AGENT FOR THAT PERSON/COMPANY. I ACKNOWLEDGE INDEBTEDNESS FOR THE WORK DONE AND MATERIALS SUPPLIED IN THE AMOUNT OF \$2,046.84 , BEING THE TOTAL AMOUNT OWING AS SHOWN HEREON, OR IN THE AMOUNT OF ANY CHEQUE OR CREDIT CARD GIVEN IN PAYMENT AND LATER DISHONOURED. TITLE TO THE GOODS DOES NOT TRANSFER UNTIL PAYMENT IS RECEIVED IN FULL FOR SAID GOODS.

Subtotal	1,949.37
AB GST/HST	97.47
Total	2,046.84
Balance	2,046.84

Agreed Terms: NET 30  
Interest of 16% per Annum Payable on Overdue Accounts.  
Preferred payment method: Electronic Funds Transfer (EFT)  
Email paymentinfo@kallire.com for details  
Cheque Payment: Send to Kal Tire Vernon Office: PO Box 1240, Vernon BC V1T 6N6

IF WE SELL IT... WE GUARANTEE IT! WE WELCOME YOUR COMMENTS! CALL US WEEKDAYS AT 8AM TO 5PM (PACIFIC TIME) AT 1-800-663-9350 OR EMAIL US AT CUSTOMERSERVICE@KALTIRE.COM

RC Partnership Ltd.  
4705 49th Ave  
Red Deer, AB T4N 3W9  
(403) 346-2266  
www.mrlube.com

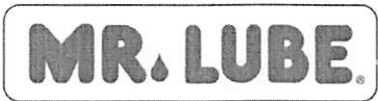

Date	08-Nov-2022 2:01 PM
Invoice #	17527076
Transaction #	22110817527076
License Plate	BC-RD5962

<b>Customer Information</b>		<b>Vehicle Information</b>																																																										
CARIBOO CENTRAL RAILROAD Kelowna, BC V1X 4H8 (250) 612-7010		KILOMETERS 69406 2021 GMC TRUCKS SIERRA 3500 PICKUP 8cyl 6.6L Diesel Turbo VIN 1GT49TEYXMF139322																																																										
<b>Fleets</b>		<b>Service History</b>																																																										
RCARCEN N Cariboo Central Railroad Ltd.		<table border="1"> <thead> <tr> <th>DATE</th> <th>KILOMETERS</th> <th>SERVICES</th> </tr> </thead> <tbody> <tr> <td>08-Nov-2022</td> <td>69406</td> <td>OC1 LUB G11 WW AF WB</td> </tr> <tr> <td>22-Aug-2022</td> <td>58666</td> <td>OC1 LUB G9 WW AF CAB DFF</td> </tr> <tr> <td>04-Jul-2022</td> <td>48546</td> <td>OC1 LUB G7 WW</td> </tr> <tr> <td>27-Jan-2022</td> <td>40407</td> <td>OC1 LUB G9 WW</td> </tr> <tr> <td>14-Oct-2021</td> <td>31254</td> <td>OC1 LUB G6 WW DFF</td> </tr> <tr> <td>11-Aug-2021</td> <td>19400</td> <td>OC1 LUB G9 G11 WW AF</td> </tr> <tr> <td>11-Jun-2021</td> <td>9532</td> <td>OC1 LUB G8 WW AF</td> </tr> </tbody> </table>		DATE	KILOMETERS	SERVICES	08-Nov-2022	69406	OC1 LUB G11 WW AF WB	22-Aug-2022	58666	OC1 LUB G9 WW AF CAB DFF	04-Jul-2022	48546	OC1 LUB G7 WW	27-Jan-2022	40407	OC1 LUB G9 WW	14-Oct-2021	31254	OC1 LUB G6 WW DFF	11-Aug-2021	19400	OC1 LUB G9 G11 WW AF	11-Jun-2021	9532	OC1 LUB G8 WW AF																																	
DATE	KILOMETERS	SERVICES																																																										
08-Nov-2022	69406	OC1 LUB G11 WW AF WB																																																										
22-Aug-2022	58666	OC1 LUB G9 WW AF CAB DFF																																																										
04-Jul-2022	48546	OC1 LUB G7 WW																																																										
27-Jan-2022	40407	OC1 LUB G9 WW																																																										
14-Oct-2021	31254	OC1 LUB G6 WW DFF																																																										
11-Aug-2021	19400	OC1 LUB G9 G11 WW AF																																																										
11-Jun-2021	9532	OC1 LUB G8 WW AF																																																										
<p>X</p> <p>I have agreed to the information contained on this invoice.</p>		<table border="1"> <thead> <tr> <th>Description</th> <th>QTY</th> <th>Price</th> </tr> </thead> <tbody> <tr> <td>SELECT DIESEL PACKAGE</td> <td>1.00</td> <td>124.99</td> </tr> <tr> <td>SHOP SUPPLIES</td> <td>1.00</td> <td>7.99</td> </tr> <tr> <td>COURTESY CHECK</td> <td>1.00</td> <td>0.00</td> </tr> <tr> <td>OIL FILTER PH26</td> <td>1.00</td> <td>0.00</td> </tr> <tr> <td>SPECIAL FILTER CHARGE \$6</td> <td>1.00</td> <td>6.00</td> </tr> <tr> <td>MOBIL DELVAC 1300 15W40</td> <td>9.50</td> <td>0.00</td> </tr> <tr> <td>TIRE PRESSURE IS ===&gt;</td> <td>60.80</td> <td>0.00</td> </tr> <tr> <td>CHASSIS LUB. 2-14 PTS.</td> <td>1.00</td> <td>0.00</td> </tr> <tr> <td>11 GREASE FITTINGS LUBED</td> <td>1.00</td> <td>0.00</td> </tr> <tr> <td>FREE WASHER FLUID TOP-UP</td> <td>1.00</td> <td>0.00</td> </tr> <tr> <td>WINTER WASHER FLUID BULK</td> <td>1.00</td> <td>0.00</td> </tr> <tr> <td>BATTERY TEST PASSED</td> <td>1.00</td> <td>0.00</td> </tr> <tr> <td>AIR FILTER LAF9248</td> <td>1.00</td> <td>56.99</td> </tr> <tr> <td>MICHELIN PS WIPERBLADE 22</td> <td>2.00</td> <td>45.98</td> </tr> <tr> <td>SALE</td> <td></td> <td>\$241.95</td> </tr> <tr> <td>831770441-RT0001</td> <td></td> <td>12.10</td> </tr> <tr> <td><b>TOTAL</b></td> <td></td> <td><b>\$254.05</b></td> </tr> <tr> <td>CHARGE</td> <td></td> <td>254.05</td> </tr> </tbody> </table>		Description	QTY	Price	SELECT DIESEL PACKAGE	1.00	124.99	SHOP SUPPLIES	1.00	7.99	COURTESY CHECK	1.00	0.00	OIL FILTER PH26	1.00	0.00	SPECIAL FILTER CHARGE \$6	1.00	6.00	MOBIL DELVAC 1300 15W40	9.50	0.00	TIRE PRESSURE IS ===>	60.80	0.00	CHASSIS LUB. 2-14 PTS.	1.00	0.00	11 GREASE FITTINGS LUBED	1.00	0.00	FREE WASHER FLUID TOP-UP	1.00	0.00	WINTER WASHER FLUID BULK	1.00	0.00	BATTERY TEST PASSED	1.00	0.00	AIR FILTER LAF9248	1.00	56.99	MICHELIN PS WIPERBLADE 22	2.00	45.98	SALE		\$241.95	831770441-RT0001		12.10	<b>TOTAL</b>		<b>\$254.05</b>	CHARGE		254.05
Description	QTY	Price																																																										
SELECT DIESEL PACKAGE	1.00	124.99																																																										
SHOP SUPPLIES	1.00	7.99																																																										
COURTESY CHECK	1.00	0.00																																																										
OIL FILTER PH26	1.00	0.00																																																										
SPECIAL FILTER CHARGE \$6	1.00	6.00																																																										
MOBIL DELVAC 1300 15W40	9.50	0.00																																																										
TIRE PRESSURE IS ===>	60.80	0.00																																																										
CHASSIS LUB. 2-14 PTS.	1.00	0.00																																																										
11 GREASE FITTINGS LUBED	1.00	0.00																																																										
FREE WASHER FLUID TOP-UP	1.00	0.00																																																										
WINTER WASHER FLUID BULK	1.00	0.00																																																										
BATTERY TEST PASSED	1.00	0.00																																																										
AIR FILTER LAF9248	1.00	56.99																																																										
MICHELIN PS WIPERBLADE 22	2.00	45.98																																																										
SALE		\$241.95																																																										
831770441-RT0001		12.10																																																										
<b>TOTAL</b>		<b>\$254.05</b>																																																										
CHARGE		254.05																																																										
<b>Messages</b>																																																												
We hope you loved your service today; please give us a Great Google Review & mention your technician by name! Thank-you for choosing Mr. Lube; please tell a friend!																																																												
<b>Recommend next service on 06-Feb-2023 or 74406 km.</b>																																																												
<b>Employees</b>																																																												
UPPER	LOWER	COURTESY																																																										
DYLAN	ASHTON	KUMAR																																																										
<b>Service Comments</b>																																																												
Thank You! HAVE A NICE DAY!																																																												
<b>Warranty Approved Service</b>																																																												
At Mr. Lube, oil changes are warranty-approved and Mr. Lube precisely follows the service intervals and product specifications your vehicle's manufacturer recommends for the exact make, model and year of your car.																																																												

Job Code: BC . CN . FC2 . HR  
Task Code: A16NB  
Equipment Unit #: 74  
Comment: LOF

DocuSigned by:  
*Tammy Froelich*  
275231AE148B49C...  
NOV 8, 2022

Rec Nov 08/22

# Complete our survey and receive a chance to WIN!

- ✓ Win a FREE oil change weekly
- ✓ Receive 10 chances to win \$1,000 daily
- ✓ You could instantly win other great prizes valued at \$1,500 weekly

## We value your feedback.

Rate us at [www.tellmrlube.com](http://www.tellmrlube.com), or call 1-866-681-4932 and you could win a free oil change weekly!

PLUS receive a chance to win daily cash and other great prizes by visiting [tellmrlube.com](http://tellmrlube.com) or calling 1-866-681-4932

Survey Code:  
13P0A5JN2H

Enter this code at [tellmrlube.com](http://tellmrlube.com)

RC Partnership Ltd.  
4705 49th Ave  
Red Deer, AB T4N 3W9  
(403) 346-2266  
www.mrlube.com

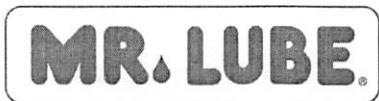

Date	08-Nov-2022 2:01 PM
Invoice #	17527076
Transaction #	22110817527076
License Plate	BC-RD5962

**Courtesy Checklist**

**COURTESY CHECK / DOUBLE CHECK**

<b>CHECKS:</b>			
-Washer Fluid	TOPUP	-Windshield	APPEARS OK
-Coolant Fluid	LEVEL OK	-Transmission/Transaxle Fluid	LEVEL OK
-Power Steering Fluid	LEVEL OK	-Lights	CHECKED OK
-Serpentine Belt	NO CHECK	-Leaks (Fluid, Oil)	APPEARS OK
-Air Filter	REPLACED	<b>TIRE SERVICE CHECKS:</b>	
-Cabin Air Filter	NO CHECK	-Tire Pressure	TIRE PRESSURE OK
-Battery	PASS	<b>DOUBLE CHECKS:</b>	
-Wash Windows	COMPLETED	-Oil Pan Drain Plug	CHECK
-Wiper Blades Front/Rear	REPLACED	-Oil Filter	CHECK
		-Oil Light Reset	RESET

**DISCLAIMER**

RC Partnership Ltd. is the "Operator" of this Mr. Lube Store. BE ADVISED that the courtesy checks provided in connection with the servicing of your vehicle are provided solely as a courtesy and for your information only. The Operator does not represent or warrant that the courtesy checks are in any way comprehensive or that the results of the courtesy checks are accurate. The Operator disclaims any and all responsibility for ensuring that your vehicle is in proper working condition with respect to the parts, components or matters inspected or reviewed in the courtesy checks or that it is safe for you or any other person to operate. In no event will the Operator or any of its directors, officers, employees, agents or representatives be liable in any way for any loss or damage whatsoever (including personal injury or death) resulting or arising from, or in any way connected with, any failure of any of the parts, components or matters inspected or reviewed in the courtesy checks.

# Complete our survey and receive a chance to WIN!

- ✓ Win a FREE oil change weekly
- ✓ Receive 10 chances to win \$1,000 daily\*
- ✓ You could instantly win other great prizes valued at \$1,500 weekly\*

**We value your feedback.**

Rate us at [www.tellmrlube.com](http://www.tellmrlube.com), or call 1-866-681-4932 and you could win a free oil change weekly!

**PLUS** receive a chance to win daily cash and other great prizes by visiting [tellmrlube.com](http://tellmrlube.com) or calling 1-866-681-4932

**Survey Code:**  
**13P0A5JN2H**

Enter this code at [tellmrlube.com](http://tellmrlube.com)

\*Check inmoment.com for contest details. © Reg. TM/MD of ML Royalties Limited Partnership, used under license.

RC Partnership Ltd.  
4705 49th Ave  
Red Deer, AB T4N 3W9  
(403) 346-2266  
www.mrlube.com

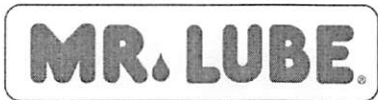

Date	22-Aug-2022 11:47 AM
Invoice #	17566289
Transaction #	22082217566289
License Plate	BC-RD5962

<b>Customer Information</b>		<b>Vehicle Information</b>																																																													
CARIBOO CENTRAL RAILROAD Kelowna, BC V1X 4H8 (250) 612-7010		KILOMETERS 58666 2021 GMC TRUCKS SIERRA 3500 PICKUP 8cyl 6.6L Diesel Turbo VIN 1GT49TEYXMF139322																																																													
<b>Fleets</b>		<b>Service History</b>																																																													
RCARCEN N Cariboo Central Railroad Ltd. 74		<table border="1"> <thead> <tr> <th>DATE</th> <th>KILOMETERS</th> <th>SERVICES</th> </tr> </thead> <tbody> <tr> <td>22-Aug-2022</td> <td>58666</td> <td>OC1 LUB G9 WW AF CAB DFF</td> </tr> <tr> <td>04-Jul-2022</td> <td>48546</td> <td>OC1 LUB G7 WW</td> </tr> <tr> <td>27-Jan-2022</td> <td>40407</td> <td>OC1 LUB G9 WW</td> </tr> <tr> <td>14-Oct-2021</td> <td>31254</td> <td>OC1 LUB G6 WW DFF</td> </tr> <tr> <td>11-Aug-2021</td> <td>19400</td> <td>OC1 LUB G9 G11 WW AF</td> </tr> <tr> <td>11-Jun-2021</td> <td>9532</td> <td>OC1 LUB G8 WW AF</td> </tr> </tbody> </table>		DATE	KILOMETERS	SERVICES	22-Aug-2022	58666	OC1 LUB G9 WW AF CAB DFF	04-Jul-2022	48546	OC1 LUB G7 WW	27-Jan-2022	40407	OC1 LUB G9 WW	14-Oct-2021	31254	OC1 LUB G6 WW DFF	11-Aug-2021	19400	OC1 LUB G9 G11 WW AF	11-Jun-2021	9532	OC1 LUB G8 WW AF																																							
DATE	KILOMETERS	SERVICES																																																													
22-Aug-2022	58666	OC1 LUB G9 WW AF CAB DFF																																																													
04-Jul-2022	48546	OC1 LUB G7 WW																																																													
27-Jan-2022	40407	OC1 LUB G9 WW																																																													
14-Oct-2021	31254	OC1 LUB G6 WW DFF																																																													
11-Aug-2021	19400	OC1 LUB G9 G11 WW AF																																																													
11-Jun-2021	9532	OC1 LUB G8 WW AF																																																													
<p>X</p> <p>I have agreed to the information contained on this invoice.</p>		<table border="1"> <thead> <tr> <th>Description</th> <th>QTY</th> <th>Price</th> </tr> </thead> <tbody> <tr> <td>SELECT DIESEL PACKAGE</td> <td>1.00</td> <td>124.99</td> </tr> <tr> <td>SHOP SUPPLIES</td> <td>1.00</td> <td>7.99</td> </tr> <tr> <td>COURTESY CHECK</td> <td>1.00</td> <td>0.00</td> </tr> <tr> <td>OIL FILTER PH26</td> <td>1.00</td> <td>0.00</td> </tr> <tr> <td>SPECIAL FILTER CHARGE \$6</td> <td>1.00</td> <td>6.00</td> </tr> <tr> <td>MOBIL DELVAC 1300 15W40</td> <td>9.50</td> <td>0.00</td> </tr> <tr> <td>TIRE PRESSURE IS ===&gt;</td> <td>60.80</td> <td>0.00</td> </tr> <tr> <td>CHASSIS LUB. 2-14 PTS.</td> <td>1.00</td> <td>0.00</td> </tr> <tr> <td>9 GREASE FITTINGS LUBED</td> <td>1.00</td> <td>0.00</td> </tr> <tr> <td>FREE WASHER FLUID TOP-UP</td> <td>1.00</td> <td>0.00</td> </tr> <tr> <td>WINTER WASHER FLUID BULK</td> <td>1.00</td> <td>0.00</td> </tr> <tr> <td>BATTERY TEST PASSED</td> <td>1.00</td> <td>0.00</td> </tr> <tr> <td>AIR FILTER LAF9248</td> <td>1.00</td> <td>56.99</td> </tr> <tr> <td>LUBERFINER CAF1904C</td> <td>1.00</td> <td>89.99</td> </tr> <tr> <td>DIESEL FUEL FILTER L9999F</td> <td>1.00</td> <td>129.99</td> </tr> <tr> <td>SALE</td> <td></td> <td>\$415.95</td> </tr> <tr> <td>831770441-RT0001</td> <td></td> <td>20.80</td> </tr> <tr> <td><b>TOTAL</b></td> <td></td> <td><b>\$436.75</b></td> </tr> <tr> <td>CHARGE</td> <td></td> <td>436.75</td> </tr> </tbody> </table>		Description	QTY	Price	SELECT DIESEL PACKAGE	1.00	124.99	SHOP SUPPLIES	1.00	7.99	COURTESY CHECK	1.00	0.00	OIL FILTER PH26	1.00	0.00	SPECIAL FILTER CHARGE \$6	1.00	6.00	MOBIL DELVAC 1300 15W40	9.50	0.00	TIRE PRESSURE IS ===>	60.80	0.00	CHASSIS LUB. 2-14 PTS.	1.00	0.00	9 GREASE FITTINGS LUBED	1.00	0.00	FREE WASHER FLUID TOP-UP	1.00	0.00	WINTER WASHER FLUID BULK	1.00	0.00	BATTERY TEST PASSED	1.00	0.00	AIR FILTER LAF9248	1.00	56.99	LUBERFINER CAF1904C	1.00	89.99	DIESEL FUEL FILTER L9999F	1.00	129.99	SALE		\$415.95	831770441-RT0001		20.80	<b>TOTAL</b>		<b>\$436.75</b>	CHARGE		436.75
Description	QTY	Price																																																													
SELECT DIESEL PACKAGE	1.00	124.99																																																													
SHOP SUPPLIES	1.00	7.99																																																													
COURTESY CHECK	1.00	0.00																																																													
OIL FILTER PH26	1.00	0.00																																																													
SPECIAL FILTER CHARGE \$6	1.00	6.00																																																													
MOBIL DELVAC 1300 15W40	9.50	0.00																																																													
TIRE PRESSURE IS ===>	60.80	0.00																																																													
CHASSIS LUB. 2-14 PTS.	1.00	0.00																																																													
9 GREASE FITTINGS LUBED	1.00	0.00																																																													
FREE WASHER FLUID TOP-UP	1.00	0.00																																																													
WINTER WASHER FLUID BULK	1.00	0.00																																																													
BATTERY TEST PASSED	1.00	0.00																																																													
AIR FILTER LAF9248	1.00	56.99																																																													
LUBERFINER CAF1904C	1.00	89.99																																																													
DIESEL FUEL FILTER L9999F	1.00	129.99																																																													
SALE		\$415.95																																																													
831770441-RT0001		20.80																																																													
<b>TOTAL</b>		<b>\$436.75</b>																																																													
CHARGE		436.75																																																													
<b>Messages</b>																																																															
We hope you loved your service today; please give us a Great Google Review & mention your technician by name! Thank-you for choosing Mr. Lube; please tell a friend!																																																															
<b>Recommend next service on 20-Nov-2022 or 63666 km.</b>																																																															
<b>Employees</b>																																																															
UPPER	LOWER	COURTESY																																																													
ANDREI	BOJAN	TRENT																																																													
<b>Service Comments</b>																																																															
HAVE A NICE DAY! Thank You!																																																															
<b>Warranty Approved Service</b>																																																															
At Mr. Lube, oil changes are warranty-approved and Mr. Lube precisely follows the service intervals and product specifications your vehicle's manufacturer recommends for the exact make, model and year of your car.																																																															

Job Code: BC.CN.FC2.HR

Task Code: A16NB

Equipment Unit #: 74

Comment: LOF

DocuSigned by:  
*Tammy Froelich*  
275231AF148B49C...  
Aug 24, 2022

Rec Aug 22/22

# Complete our survey and receive a chance to WIN!

- ✓ Win a FREE oil change weekly
- ✓ Receive 10 chances to win \$1,000 daily\*
- ✓ You could instantly win other great prizes valued at \$1,500 weekly\*

## We value your feedback.

Rate us at [www.tellmrlube.com](http://www.tellmrlube.com), or call 1-866-681-4932 and you could win a free oil change weekly!

PLUS receive a chance to win daily cash and other great prizes by visiting [tellmrlube.com](http://tellmrlube.com) or calling 1-866-681-4932

Survey Code:  
13MP36ZVW9

Enter this code at [tellmrlube.com](http://tellmrlube.com)

\*Check [inmoment.com](http://inmoment.com) for contest details. © Reg. TM/MD of ML Royalties Limited Partnership, used under license.

RC Partnership Ltd.  
4705 49th Ave  
Red Deer, AB T4N 3W9  
(403) 346-2266  
www.mrlube.com



Date	22-Aug-2022 11:47 AM
Invoice #	17566289
Transaction #	22082217566289
License Plate	BC-RD5962

### Courtesy Checklist

#### COURTESY CHECK / DOUBLE CHECK

<b>CHECKS:</b>			
-Washer Fluid	TOPUP	-Transfer Case/PTU Fluid Level	LEVEL OK
-Coolant Fluid	LEVEL OK	-Differential Fluid Level - Front	LEVEL OK
-Power Steering Fluid	LEVEL OK	-Lights	CHECKED OK
-Serpentine Belt	NO CHECK	-Leaks (Fluid, Oil)	APPEARS OK
-Air Filter	REPLACED	<b>TIRE SERVICE CHECKS:</b>	
-Cabin Air Filter	REPLACED	-Tire Pressure	TIRE PRESSURE OK
-Battery	PASS	<b>DOUBLE CHECKS:</b>	
-Wash Windows	COMPLETED	-Oil Pan Drain Plug	CHECK
-Wiper Blades Front/Rear	NO CHECK	-Oil Filter	CHECK
-Windshield	NO CHECK	-Front Differential Plug	CHECK
-Transmission/Transaxle Fluid	LEVEL OK	-Transfer Case/PTU Plug	CHECK
-Differential Fluid Level - Rear	LEVEL OK	-Rear Differential Plug	CHECK
		-Oil Light Reset	RESET

#### DISCLAIMER

RC Partnership Ltd. is the "Operator" of this Mr. Lube Store. BE ADVISED that the courtesy checks provided in connection with the servicing of your vehicle are provided solely as a courtesy and for your information only. The Operator does not represent or warrant that the courtesy checks are in any way comprehensive or that the results of the courtesy checks are accurate. The Operator disclaims any and all responsibility for ensuring that your vehicle is in proper working condition with respect to the parts, components or matters inspected or reviewed in the courtesy checks or that it is safe for you or any other person to operate. In no event will the Operator or any of its directors, officers, employees, agents or representatives be liable in any way for any loss or damage whatsoever (including personal injury or death) resulting or arising from, or in any way connected with, any failure of any of the parts, components or matters inspected or reviewed in the courtesy checks.

## Complete our survey and receive a chance to WIN!

- ✓ Win a FREE oil change weekly
- ✓ Receive 10 chances to win \$1,000 daily\*
- ✓ You could instantly win other great prizes valued at \$1,500 weekly\*

#### We value your feedback.

Rate us at [www.tellmrlube.com](http://www.tellmrlube.com), or call 1-866-681-4932 and you could win a free oil change weekly!

PLUS receive a chance to win daily cash and other great prizes by visiting [tellmrlube.com](http://tellmrlube.com) or calling 1-866-681-4932

Survey Code:  
13MP36ZVW9

Enter this code at [tellmrlube.com](http://tellmrlube.com)



1951 1st Ave.  
PRINCE GEORGE, BC V2L 2Y8  
TEL: (250) 562-6760

**BRANCH OFFICE:**  
17210 - 103 AVENUE  
EDMONTON, AB T5S 1N1  
TEL: (780) 451-0030

**BRANCH OFFICE:**  
10016 -124th AVENUE  
GRANDE PRAIRIE, AB T8V 5L7  
TEL: (780) 402-2255

DATE
12-15-21
NUMBER
Q55331



S  
C  
L  
C  
T  
C  
CARIBOO CENTRAL RAILROAD  
CONTRACTING LTD.  
#209 - 307 BANKS RD.  
KELOWNA, BC V1X 6A1

S  
H  
I  
P  
T  
O

**SPECIAL**

**INSTRUCTIONS:**

A RESTOCKING FEE MAY BE CHARGED ON RETURNED GOODS.  
INTEREST CHARGED AT 1.5% PER MONTH (19.56% PER ANNUM) ON OVERDUE ACCOUNTS.

SERVER	ACCT. NO.	PST #	ORDER NO.	SHIP VIA	PAGE	P.O. NUMBER
DAVE		00	967164		1	UNIT 74

Part Number	Description	Qty	Shp	B/O	List	Price	Ext
LO-S5D1-SAE20	20" LED LIGHT BAR SAE/D 5 WATT SINGLE ROW IGNITER SERIES	1	1	0	177.20	132.90	132.90
AB	INSTALL LIGHTBAR	3	3	0	120.00		360.00
SHOP	SUPPLIES	1	1	0	1.00	65.00	65.00

INSTALL BEHIND GRILL AT BOTTOM  
APPT DECEMBER 15 830AM

Job Code: MechanicalF22  
Task Code: A99  
Equipment Unit #: 74  
Comment: LIGHT BAR

DocuSigned by:  
*Tammy Froelich*  
275231AF148B49C...  
Dec 23, 2021

Rec Dec 15/21

GST# 102506680

PLEASE REMIT PAYMENT TO HEAD OFFICE.

SUB TOTAL	557.90
GST/HST	27.90
PST	39.05
TOTAL	624.85

INVOICE COPY



**Kelowna**

Phone (250) 712-1222 Fax

2320 Highway 97 N.  
Kelowna BC V1X 4H8

Invoice To

**Cariboo Central Railroad Contracting Ltd.**

#209 - 307 Banks Road  
Kelowna, BC, V1X 6A1, Canada  
Billing Account: 312039  
Terms: Net 30

Invoice **M3048271-7**

GST No.: R102214632  
Invoice Date: **2021-08-25**  
Invoiced Period: 2021-08-25, 22:08 to 2021-08-25, 22:08  
PO No.: 47  
Ordered by: Cam F  
Phone No.: (604)613-5005

Vehicle **170276**

2021 GMC Sierra 3500HD 4WD Crew Cab 159" SLE (Colour: White)  
VIN: 1GT49TEYXMF139322  
License Plate: RD5962

Charges

Charge Type	Description	Subtotal	PST	GST/HST	Total
Mechanical Repairs	Oil change	\$177.97		\$8.90	\$186.87
		\$177.97		\$8.90	\$186.87

Billing To

Bill-To account: 312039

**Total:** \$186.87  
**Payments Collected:** \$0.00  
**Amount Due:** \$186.87

Job Code: Mechanical.F22

Task Code: A99

Equipment Unit #: Unit 74

Comment: oil change

DocuSigned by:

*Cam Fraser*  
12188F15F0CD418...

Aug 27, 2021

Notes

Tonneau cover required.

Rec Aug 25/21



Kelowna

Phone (250) 712-1222 Fax

2320 Highway 97 N.  
Kelowna BC V1X 4H8

## Invoice To

**Cariboo Central Railroad Contracting Ltd.**#209 - 307 Banks Road  
Kelowna, BC, V1X 6A1, Canada  
Billing Account: 312039  
Terms: Net 30Invoice **M3048271-4**GST No.: R102214632  
Invoice Date: **2021-06-15**  
Invoiced Period: 2021-06-15, 22:31 to 2021-06-15, 22:31  
PO No.: 47  
Ordered by: Cam F  
Phone No.: (604)613-5005Vehicle **170276**2021 GMC Sierra 3500HD 4WD Crew Cab 159" SLE (Colour: White)  
VIN: 1GT49TEYXMF139322  
License Plate: RD5962

## Charges

Charge Type	Description	Subtotal	PST	GST/HST	Total
Mechanical Repairs	Oil Change - Mr. Lube INV23501980	\$171.97		\$8.60	\$180.57
		\$171.97		\$8.60	\$180.57
<b>Total:</b>					<b>\$180.57</b>
Payments Collected:					\$0.00
<b>Amount Due:</b>					<b>\$180.57</b>

## Billing To

Bill-To account: 312039

## Notes

Tonneau cover required.

Job Code: Mechanical F22

Task Code: A99

Equipment Unit #: unit 74

Comment: oil change

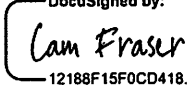
DocuSigned by:  
  
 12188F15F0CD418...  
 Jun 17, 2021

Rec Jun 15/21
---------------

**MR. LUBE STORE #235**

BIT VENTURES LTD  
 1032 RECPLACE DRIVE  
 PRINCE GEORGE, BC V2N 0G2  
 (236) 423-4215  
 www.mrlube.com



Date 14-Oct-2021 11:40 AM  
 Invoice # 23505500  
 Transaction # 21101423505500  
 License Plate BC-RD5962

<b>Customer Information</b>		<b>Vehicle Information</b>																																																										
UNIT 74 Kelowna, BC V1X 4H8 (778) 760-3768		KILOMETERS 31254 2021 GMC TRUCKS SIERRA 3500 PICKUP 8cyl 6.6L Diesel Turbo VIN 1GT49TEYXMF139322																																																										
<b>Fleets</b>		<b>Service History</b>																																																										
RDRIFOR N The Driving Force Inc. PO NUMBER 74		<table border="1"> <thead> <tr> <th>DATE</th> <th>KILOMETERS</th> <th>SERVICES</th> </tr> </thead> <tbody> <tr> <td>14-Oct-2021</td> <td>31254</td> <td>OC1 LUB G6 WW DFF</td> </tr> <tr> <td>11-Aug-2021</td> <td>19400</td> <td>OC1 LUB G9 G11 WW AF</td> </tr> <tr> <td>11-Jun-2021</td> <td>9532</td> <td>OC1 LUB G8 WW AF</td> </tr> </tbody> </table>		DATE	KILOMETERS	SERVICES	14-Oct-2021	31254	OC1 LUB G6 WW DFF	11-Aug-2021	19400	OC1 LUB G9 G11 WW AF	11-Jun-2021	9532	OC1 LUB G8 WW AF																																													
DATE	KILOMETERS	SERVICES																																																										
14-Oct-2021	31254	OC1 LUB G6 WW DFF																																																										
11-Aug-2021	19400	OC1 LUB G9 G11 WW AF																																																										
11-Jun-2021	9532	OC1 LUB G8 WW AF																																																										
<p>X</p> <p>I have agreed to the information contained on this invoice.</p>		<table border="1"> <thead> <tr> <th>Description</th> <th>QTY</th> <th>Price</th> </tr> </thead> <tbody> <tr><td>SELECT DIESEL PACKAGE</td><td>1.00</td><td>109.99</td></tr> <tr><td>SHOP SUPPLIES</td><td>1.00</td><td>4.99</td></tr> <tr><td>COURTESY CHECK</td><td>1.00</td><td>0.00</td></tr> <tr><td>OIL FILTER PH26</td><td>1.00</td><td>0.00</td></tr> <tr><td>SPECIAL FILTER CHARGE \$6</td><td>1.00</td><td>6.00</td></tr> <tr><td>MOBIL DELVAC 1300 15W40</td><td>9.50</td><td>0.00</td></tr> <tr><td>TIRE PRESSURE IS ===&gt;</td><td>60.80</td><td>0.00</td></tr> <tr><td>CHASSIS LUB. 2-14 PTS.</td><td>1.00</td><td>0.00</td></tr> <tr><td>6 GREASE FITTINGS LUBED</td><td>1.00</td><td>0.00</td></tr> <tr><td>FREE WASHER FLUID TOP-UP</td><td>1.00</td><td>0.00</td></tr> <tr><td>WINTER WASHER FLUID BULK</td><td>1.00</td><td>0.00</td></tr> <tr><td>BATTERY TEST PASSED</td><td>1.00</td><td>0.00</td></tr> <tr><td>DIESEL FUEL FILTER L9999F</td><td>1.00</td><td>139.99</td></tr> <tr><td>SALE TAXABLE</td><td>260.97</td><td>\$260.97</td></tr> <tr><td>PST (Exempt #1014-4021)</td><td></td><td>0.00</td></tr> <tr><td>GST #71704-3913</td><td></td><td>13.05</td></tr> <tr><td><b>TOTAL</b></td><td></td><td><b>\$274.02</b></td></tr> <tr><td>CHARGE</td><td></td><td>274.02</td></tr> </tbody> </table>		Description	QTY	Price	SELECT DIESEL PACKAGE	1.00	109.99	SHOP SUPPLIES	1.00	4.99	COURTESY CHECK	1.00	0.00	OIL FILTER PH26	1.00	0.00	SPECIAL FILTER CHARGE \$6	1.00	6.00	MOBIL DELVAC 1300 15W40	9.50	0.00	TIRE PRESSURE IS ===>	60.80	0.00	CHASSIS LUB. 2-14 PTS.	1.00	0.00	6 GREASE FITTINGS LUBED	1.00	0.00	FREE WASHER FLUID TOP-UP	1.00	0.00	WINTER WASHER FLUID BULK	1.00	0.00	BATTERY TEST PASSED	1.00	0.00	DIESEL FUEL FILTER L9999F	1.00	139.99	SALE TAXABLE	260.97	\$260.97	PST (Exempt #1014-4021)		0.00	GST #71704-3913		13.05	<b>TOTAL</b>		<b>\$274.02</b>	CHARGE		274.02
Description	QTY	Price																																																										
SELECT DIESEL PACKAGE	1.00	109.99																																																										
SHOP SUPPLIES	1.00	4.99																																																										
COURTESY CHECK	1.00	0.00																																																										
OIL FILTER PH26	1.00	0.00																																																										
SPECIAL FILTER CHARGE \$6	1.00	6.00																																																										
MOBIL DELVAC 1300 15W40	9.50	0.00																																																										
TIRE PRESSURE IS ===>	60.80	0.00																																																										
CHASSIS LUB. 2-14 PTS.	1.00	0.00																																																										
6 GREASE FITTINGS LUBED	1.00	0.00																																																										
FREE WASHER FLUID TOP-UP	1.00	0.00																																																										
WINTER WASHER FLUID BULK	1.00	0.00																																																										
BATTERY TEST PASSED	1.00	0.00																																																										
DIESEL FUEL FILTER L9999F	1.00	139.99																																																										
SALE TAXABLE	260.97	\$260.97																																																										
PST (Exempt #1014-4021)		0.00																																																										
GST #71704-3913		13.05																																																										
<b>TOTAL</b>		<b>\$274.02</b>																																																										
CHARGE		274.02																																																										
<b>Messages</b>																																																												
THANKS FOR CHOOSING US. WE LOOK FOWARD TO YOUR RETURN																																																												
<b>Recommend next service on 12-Jan-2022 or 36254 km.</b>																																																												
<b>Employees</b>																																																												
UPPER	LOWER	COURTESY	TIRE																																																									
KORAL	ADAM	JAMIE																																																										
<b>Service Comments</b>																																																												
THANK YOU																																																												
<b>Warranty Approved Service</b>																																																												
At Mr. Lube, oil changes are warranty-approved and Mr. Lube precisely follows the service intervals and product specifications your vehicle's manufacturer recommends for the exact make, model and year of your car.																																																												

# Complete our survey and receive a chance to WIN!

- ✓ Win a FREE oil change weekly
- ✓ Receive 10 chances to win \$1,000 daily\*
- ✓ You could instantly win other great prizes valued at \$1,500 weekly\*

**We value your feedback.**

Rate us at [www.tellmrlube.com](http://www.tellmrlube.com), or call 1-866-681-4932 and you could win a free oil change weekly!

PLUS receive a chance to win daily cash and other great prizes by visiting [tellmrlube.com](http://tellmrlube.com) or calling 1-866-681-4932

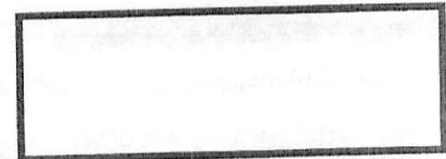

Enter this code at [tellmrlube.com](http://tellmrlube.com)

\*Check inmoment.com for contest details. ® Reg. TM/MD of ML Royalties Limited Partnership, used under license

MR. LUBE STORE #235  
KBT VENTURES LTD  
3032 REPLACE DRIVE  
PRINCE GEORGE, BC V2N 0G2  
(236) 423-4215  
www.mrlube.com



Date	14-Oct-2021 11:40 AM
Invoice #	23505500
Transaction #	21101423505500
License Plate	BC-RD5962

Courtesy Checklist

**COURTESY CHECK / DOUBLE CHECK**

CHECKS:

- Washer Fluid
- Coolant Fluid
- Power Steering Fluid
- Serpentine Belt
- Air Filter
- Cabin Air Filter
- Battery
- Wash Windows
- Wiper Blades Front/Rear

- TOPUP
- LEVEL OK
- LEVEL OK
- NO CHECK
- APPEARS OK
- NO CHECK
- PASS
- COMPLETED
- APPEARS OK

- Windshield
- Transmission/Transaxle Fluid
- Lights
- Leaks (Fluid, Oil)
- TIRE SERVICE CHECKS:
- Tire Pressure
- DOUBLE CHECKS:
- Oil Pan Drain Plug
- Oil Filter
- Fuel Filter

- APPEARS OK
- LEVEL OK
- CHECKED OK
- APPEARS OK
- TIRE PRESSURE OK
- CHECK
- CHECK
- CHECK

**DISCLAIMER**

KBT VENTURES LTD is the "Operator" of this Mr. Lube Store. BE ADVISED that the courtesy checks provided in connection with the servicing of your vehicle are provided solely as a courtesy and for your information only. The Operator does not represent or warrant that the courtesy checks are in any way comprehensive or that the results of the courtesy checks are accurate. The Operator disclaims any and all responsibility for ensuring that your vehicle is in proper working condition with respect to the parts, components or matters inspected or reviewed in the courtesy checks or that it is safe for you or any other person to operate. In no event will the Operator or any of its directors, officers, employees, agents or representatives be liable in any way for any loss or damage whatsoever (including personal injury or death) resulting or arising from, or in any way connected with, any failure of any of the parts, components or matters inspected or reviewed in the courtesy checks.

# Complete our survey and receive a chance to WIN!

- ✓ Win a FREE oil change weekly
- ✓ Receive 10 chances to win \$1,000 daily\*
- ✓ You could instantly win other great prizes valued at \$1,500 weekly\*

### We value your feedback.

Rate us at [www.tellmrlube.com](http://www.tellmrlube.com), or call 1-866-681-4932 and you could win a free oil change weekly!

**PLUS** receive a chance to win daily cash and other great prizes by visiting [tellmrlube.com](http://tellmrlube.com) or calling 1-866-681-4932

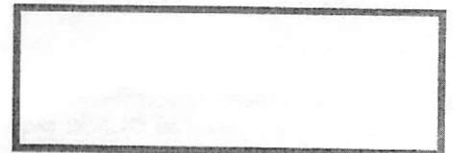

Enter this code at [tellmrlube.com](http://tellmrlube.com)

\*Check [moment.com](http://moment.com) for contest details. Reg. TM/MD of ML Royalties Limited Partnership, used under license.