

Experian AutoCheck Report

Report run: 06/30/2026 10:00:38 EDT

2018 Dodge Grand Caravan SE / SE Plus

Passenger 4D (3.6L V6 SMPI Flex Fuel)

VIN:	2C4RDGBG7JR215087
Class:	Van - Mini
Country of Assembly:	Canada
Vehicle Age:	8 year(s)
Estimated In Service:	03/02/2018
Last Reported Odometer:	98,280 (05/06/2025)

Owners - 3



Vehicle Usage
Fleet, Lease, Rental



AutoCheck Score

Similar vehicles usually range between 85 and 91

Vehicle History at a Glance

<p>State Title Brand Odometer Brand</p> <p>TITLE BRAND REPORTED</p>	<p>Auction Brand / Issues Odometer Problem, Structural Damage</p> <p>AUCTION ISSUE REPORTED</p>	<p>Accident / Damage Structural Damage</p> <p>SEVERE</p>
<p>Open Recall Check</p> <p>NO OPEN RECALLS</p>	<p>Insurance Loss / Transfer</p> <p>NO ISSUE</p>	<p>Odometer Check Last reported odometer: 98,280 (05/06/2025)</p> <p>ODOMETER ISSUE REPORTED</p>
<p>Certified Pre-Owned</p> <p>NO CPO INFO AVAILABLE</p>	<p>Service / Repair 4 Service Record(s) Reported</p> <p>NO ISSUE</p>	<p>Additional History Lien Reported</p> <p>EVENTS REPORTED</p>



This vehicle is not eligible for Buyback Protection

Due to the vehicle's history showing no reported major state title brands. [Terms & Conditions](#)

[Learn More](#)



Accident & Damage

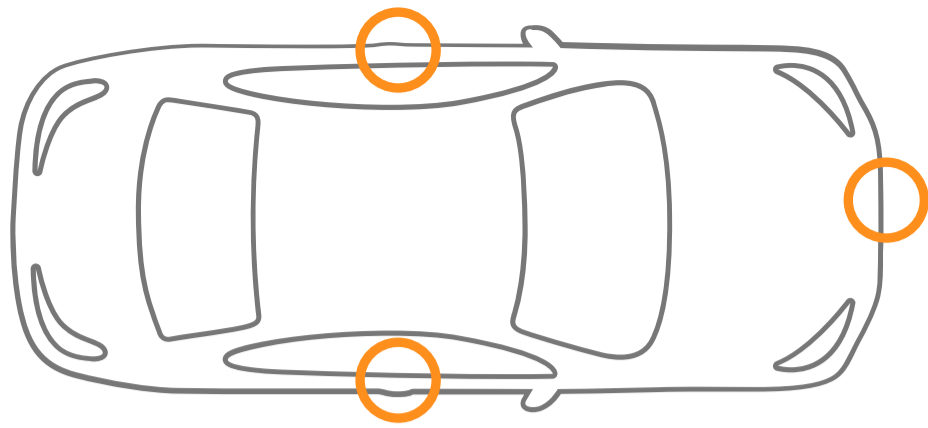

Airbag Deployed



Overturned



Structural Damage



Severe

Damage Date	Damage Type	Severity
05/13/2022	Collision	Moderate
10/18/2023	Structural Damage	Severe
02/11/2024	Structural Damage	Severe
05/06/2025	Structural Damage	Severe
08/14/2025	Structural Damage	Severe

Accident or damage event(s) have been reported for this vehicle to Experian AutoCheck. An inspection may provide added confidence in the vehicle's condition before purchase.

Service History

Service History Summary

Below is a summary of services that have been reported for this vehicle. Please note that not all maintenance events are reported to Experian AutoCheck.



Regular Oil Changes

- 3 oil services reported
- Last oil service reported 05/28/2020



Fluids Maintained

- 1 coolant flushes
- Last fluid maintained 05/28/2020



Brakes Maintained

- 1 brake pad replacements
- Brake last maintained on 01/22/2020



Tires Maintained

Information not available.



A/C & Climate Control

- 3 A/C services reported
- A/C system last serviced 05/28/2020



Other Services

- Cabin air filter replaced on 01/22/2020
- Battery replaced on 05/28/2020

OEM Recommended Services



90000 Mile Service

- Change engine oil and engine oil filter
- Inspect battery and clean and tighten terminals as required
- Inspect brake pads, shoes, rotors, drums, hoses and parking brake



100000 Mile Service Not Yet Due

- Change engine oil and engine oil filter
- Inspect and replace PCV valve if necessary
- Inspect battery and clean and tighten terminals as required

Odometer Check



Problem Reported

One or more odometer problems have been reported to AutoCheck by the state Division of Motor Vehicles (DMV) or auction sources OR there is a potential odometer discrepancy when AutoCheck examined the sequence of reported odometer readings.



State Title Odometer Check

The State Division of Motor Vehicles has reported the following odometer brand(s):

Not Actual Miles



Auction Odometer Check

The following odometer brand(s) has been announced by an auction:

Not Actual Miles



Odometer Calculation Check

Odometer Variance

Detailed Vehicle History

2018

Vehicle Prep and Other Pre-Titling Events

Location: FL Preparation Date: 03/2018				
Event Date	Location	Odometer	Data Source	Details
03/02/2018	FL	10	Motor Vehicle Dept.	Odometer Reading from DMV

2018

Owner 1

Location: OK Owned From: 03/2018 Usage: Lease, Rental				
Event Date	Location	Odometer	Data Source	Details
03/09/2018	FL		Motor Vehicle Dept.	Title(Title #:0130350573) (Leased Vehicle) Titled or Registered as a Rental Vehicle, or Part of a Rental Fleet
04/05/2018	FL		Motor Vehicle Dept.	Registration Event/Renewal(Leased Vehicle) Titled or Registered as a Rental Vehicle, or Part of a Rental Fleet
04/01/2019	FL		Motor Vehicle Dept.	Registration Event/Renewal(Leased Vehicle) Titled or Registered as a Rental Vehicle, or Part of a Rental Fleet
04/26/2019	MI	44,190	Service Record	Cooling System Serviced Vehicle Inspected Air Filter Changed Recommended Maintenance Performed Engine Serviced Tires or Wheels Service Performed Lube, Oil And/Or Filter Changed

2019

Owner 2

Location: MI Owned From: 06/2019 Usage: Personal				
Event Date	Location	Odometer	Data Source	Details
06/12/2019	CADILLAC, MI	44,206	Motor Vehicle Dept.	Title(Title #:MI0001839394)
06/12/2019	CADILLAC, MI		Motor Vehicle Dept.	Registration Event/Renewal
01/22/2020		49,399	Alan Jay Kia 800.252.6529	Heat or Air Conditioning Serviced Air Filter Changed Multiple Point Vehicle Inspection Vehicle Detailed Brakes Serviced Tires or Wheels Service Performed Lube, Oil And/Or Filter Changed

2020

Owner 3











Location: FL Owned From: 02/2020 Usage: Fleet, Lease				
Event Date	Location	Odometer	Data Source	Details
02/08/2020	FL	49,399	Motor Vehicle Dept.	Odometer Reading from DMV
02/08/2020	SEBRING, FL		Motor Vehicle Dept.	Registration Event/Renewal(Leased Vehicle)
02/13/2020	SEBRING, FL	49,400	Dealer Record	Vehicle in Dealer Inventory
04/13/2020	SEBRING, FL		Motor Vehicle Dept.	Title(Title #:0130350573) (Lien Reported)

Event Date	Location	Odometer	Data Source	Details
05/27/2020	SEBRING, FL	60,476	Alan Jay Kia 800.252.6529	Cooling System Serviced Battery Serviced or Replaced Multiple Point Vehicle Inspection Recommended Maintenance Performed Vehicle Detailed Exhaust System Serviced Tires or Wheels Service Performed Lube, Oil And/Or Filter Changed Vehicle Fluids Serviced Promotional Service Performed
05/28/2020	FL	60,476	Service Record	Cooling System Serviced Vehicle Inspected Battery Serviced or Replaced Recommended Maintenance Performed Vehicle Detailed Wipers Replaced And/Or Serviced Exhaust System Serviced Tires or Wheels Service Performed Lube, Oil And/Or Filter Changed Vehicle Fluids Serviced Promotional Service Performed
08/13/2020	SEBRING, FL		Motor Vehicle Dept.	Registration Event/Renewal
03/24/2021	SEBRING, FL		Motor Vehicle Dept.	Registration Event/Renewal
03/11/2022	SEBRING, FL		Motor Vehicle Dept.	Registration Event/Renewal
05/13/2022	FL		Police Report	Front Impact with Another Vehicle Accident Reported(Report #:PD220513159467) Moderate Damage Reported
05/26/2022	MIAMI, FL		Damage Report	Accident or Damage Reported Vehicle Damage Reported Left Side Damage or Repair Reported Right Side Damage or Repair Reported Damage or Repair to Bumper Reported Damage or Repair to Grille Reported
12/22/2022	LAKE PLACID, FL		Motor Vehicle Dept.	Registration Event/Renewal
10/16/2023	FL		Motor Vehicle Dept.	Title(Title #:0130350573) (Lien Reported) Not Actual Miles
10/16/2023	FL		Auto Auction	Auction Announced as Fleet/Lease(COLOR REPORTED AS GREY)
10/18/2023	FL		Auto Auction	Auction Announced as Structural Damage
10/21/2023	NEW PORT RICHEY, FL	155,000	Dealer Listing	Vehicle in Dealer Inventory
11/07/2023	FL	98,277	Auto Auction	Reported at Auto Auction
11/27/2023	FL	98,277	Auto Auction	Reported at Auto Auction as Dealer Vehicle(COLOR REPORTED AS GREY)
11/30/2023	FL		Auto Auction	Auction Announced as Structural Damage
02/05/2024	FL	92,278	Auto Auction	Reported at Auto Auction as Dealer Vehicle(COLOR REPORTED AS GREY) Decrease in reported mileage - possible clerical error or rollback.
02/11/2024	FL	92,278	Auto Auction	Reported at Auto Auction
02/11/2024	FL		Auto Auction	Auction Announced as Structural Damage
03/13/2025	ONLINE DEALER	98,280	Dealer Listing	Vehicle in Dealer Inventory
03/24/2025	FL		Auto Auction	Reported at Auto Auction as Dealer Vehicle(COLOR REPORTED AS GREY)
03/25/2025	FL		Auto Auction	Reported at Auto Auction
05/05/2025	FL	98,280	Auto Auction	Reported at Auto Auction as Dealer Vehicle(COLOR REPORTED AS GREY)
05/06/2025	FL	98,280	Auto Auction	Reported at Auto Auction
05/06/2025	FL		Auto Auction	Auction Announced as Structural Damage
08/05/2025	FL		Auto Auction	Reported at Auto Auction
08/11/2025	FL		Auto Auction	Reported at Auto Auction as Dealer Vehicle(COLOR REPORTED AS GREY)
08/14/2025	FL		Auto Auction	Auction Announced as Not Actual Miles Auction Announced as Structural Damage



Warranty Check

The warranty coverage shown below is an estimate using the best available in-service date, mileage readings, and warranty information. Enter the exact odometer reading below for more accurate results. Experian AutoCheck does not guarantee coverage, please verify these results and coverage details with an authorized dealership.

Coverage Type	Remaining Miles	Remaining Time	Status	Coverage Details
Basic 	-	-		36 months / 36000 miles
Battery 	-	-	-	Contact a certified dealer to verify coverage
Corrosion 	-	-		60 months / Unlimited miles Outer Panel Corrosion Warranty. All panels are covered for 3 years/unlimited miles.
Powertrain 	-	-		60 months / 60000 miles
Roadside Assistance 	-	-		60 months / 60000 miles
Safety Restraint 	-	21 months		120 months / Unlimited miles For vehicles sold and registered in the State of Kansas, seatbelts and related seatbelt components are warranted against defects in workmanship and materials.

AutoCheck Terms and Conditions

This report, and any reliance upon it, is subject to [AutoCheck Terms and Conditions](#). If you obtained the report from a lender/dealer, the lender/dealer has been provided with these Terms and Conditions and can share them with you. These AutoCheck Terms and Conditions are also available at any time at www.autocheck.com/terms or by writing to Experian: Experian Automotive C/O AutoCheck Customer Service 1515 E. Woodfield Road, Suite 500, Schaumburg, IL 60173.

Buyback Protection Terms and Conditions

This vehicle (2C4RDGBG7JR215087) does not qualify for AutoCheck Buyback Protection.

About AutoCheck

AutoCheck vehicle history reports by Experian Automotive is the leading vehicle history reporting service. With expert data handling, the Experian Automotive database houses over 4 billion records on a half a billion vehicles. Every AutoCheck vehicle history report will give you confidence when buying or selling your next used vehicle, with superior customer service every step of the way.

Patent Notice

Certain aspects of this vehicle history report may be covered by U.S. Patent 8,005,759.